

FORCE DO BRASIL

2015

FORCE

Soartec



www.forcebrasil.com.br



Power you on!



50229S

BAÚ METÁLICO PARA FERRAMENTAS COM 9 GAVETAS

L65.5 x W31 x H43 cm 1/26.2/28.2/4.3'



PROFESSIONAL TOOLS

50235

CAIXA PARA FERRAMENTAS SANFONADA COM 5 GAVETAS

L53.5 x W25.8 x H22.5 cm 1/7.6/9/1.9'



• Tampo de plástico reforçado

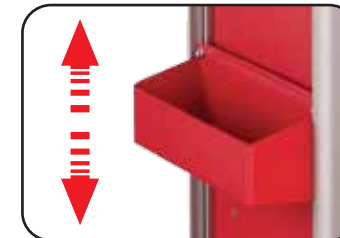

• Suporte lateral ajustável



• Trilho telescópico com rolamento
• Sistema de abertura de uma gaveta por vez



• Rodas giratórias de 5" com freio



• Cantoneira plástica de proteção

10217

10217B

10217A





Jogo de soquete com 21pçs

4212			
Código	Soquete	6/16.0/17.0/0.9'	2666g
545 08...32	Conteúdo: 1/2"DR. 21-Soquete sextavado 8; 10; 11; 12; 13; 14; 15; 16; 17; 18; 19; 20; 21; 22; 23; 24; 26; 27; 28; 30; 32 mm		



Jogo de soquete 3/8" com 25pçs

3251-72-5			
Código	Soquete	6/15.0/16.0/0.9'	2500g
537 06...22	Conteúdo: 3/8"DR. 17-Soquete sextavado 6; 7; 8; 9; 10; 11; 12; 13; 14; 15; 16; 17; 18; 19; 20; 21; 22 mm		
80239	1-Catraca 72 dentes		
8043 075...150	2-Extensão 3"; 6"		
80531	1-Junta universal		
8033165	1-Cabo de força "T"		
8073 16...20.6	2-Chave de vela 16; 20.6 mm		

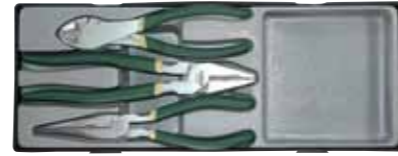

Jogo de alicate com 3pçs

5034		
Código		6/10.0/11.0/0.9'
610200	Conteúdo:	
611200	1-Alicate de bico 8"	
612175	1-Alicate universal 8"	
	1-Alicate de corte diagonal 7"	



Jogo de chave combinada com 16pçs

5161		
Código		6/14.0/15.0/0.9'
755 06...24	Conteúdo:	
	16-Chave combinada 6; 7; 8; 9; 10; 11; 12; 13; 14; 15; 16; 17; 18; 19; 22; 24 mm	



Jogo de alicate com 3pçs

5038		
Código		6/12.8/13.8/0.9'
649250B	Conteúdo:	
613B250	1-Chave ajustável/inglesa 10"	
614250	1-Alicate bomba d'água 10"	
	1-Alicate de pressão 10"	



Jogo de chave estrela 750. com 8pçs

5081			
Código	Perfil	6/13.0/14.0/0.9'	2166g
759 0607...2123	Conteúdo: 8-Chave estrela 750. 6x7; 8x9; 10x11; 12x13; 14x15; 16x17; 18x19; 21x23 mm		



Jogo de acessórios com 5pçs

4057		
Código		6/15.0/16.0/0.9'
80249	Conteúdo: 1/2"DR.	
8044 125...250	1-Catraca de 72 dentes	
8034250	2-Extensão 5"; 10"	
80541	1-Cabo de força "T"	
	1-Junta universal	



Jogo de chave com 8pçs

2084B		
Código		10/6.8/7.8/1.1'
71303B	Composição:	
713035B	6-Chave de fenda 3 mm (75mmL)	
71304B	3.5 mm (100mmL)	
713055B	4 mm (100mmL)	
713055B	5.5 mm (125mmL)	
713065B	6.5 mm (150mmL)	
71308B	8 mm (175mmL)	
	2-Chave Phillips	
7111B	PH.1 (80mmL)	
7112B	PH.2 (100mmL)	



Jogo combinado 64 pçs - catraca 72 dentes

2641			
Código	Soquete	6/15.0/16.0/0.9'	2500g
525 032...14	Composição: 1/4" DR.		
	14-Soquete sextavado curto 3.2; 4; 4.5; 5; 5.5; 6; 7; 8; 9; 10; 11; 12; 13; 14 mm		
52550 05...13	9-Soquete sextavado longo 5; 6; 7; 8; 9; 10; 11; 12; 13 mm		
32432 03...10	24-Chave soquete (32mmL) Hexagonal 3; 4; 5; 6; 7; 8; 10 mm		
32132 1...3	Phillips PH.1; PH.2; PH.3		
32232 1...3	Pozidriv PZ.1; PZ.2; PZ.3		
32332 04...065	Fenda 4; 5.5; 6.5 mm		
32632 08...40	Torx T8; T10; T15; T20; T25; T27; T30; T40		
80229	1-Catraca 72 dentes		
8042 050...150	1-Extensões 2"; 4"; 6"		
8032115	1-Cabo de força "T" 115mm		
80521	1-Junta universal		
8143	1-Chave de apoio 6"		
81225	1-Soquete imantado		
5102XLB	1-Jogo de chave "L" hexagonal abaulada com 10pçs		
7650127XL...10XL	1.27; 1.5; 2; 2.5; 3; 4; 5; 6; 8; 10 mm		



Jogo Torx com 41pçs

4413			
Código		6/14.8/15.8/0.9'	2466g
766 10...70	Conteúdo: 1/4" & 3/8" & 1/2"DR.		
	12-Chave "L" Torx T10; T15; T20; T25; T27; T30; T40; T45; T50; T55; T60; T70		
526 04...10	6-Soquete Torx 1/4" E4; E5; E6; E7; E8; E10		
536 10...20	7-Soquete Torx 3/8" E10; E11; E12; E14; E16; E18; E20		
546 22...24	2-Soquete Torx 1/2" E22; E24		
32632 08...40	9-Chave soquete Torx 1/4" (32mmL) T8; T9; T10; T15; T20; T25; T27; T30; T40		
33650 45...50	2-Chave soquete Torx 3/8" (50mmL) T45; T50		
346100 60...70	2-Chave soquete Torx 1/2" (100mmL) T60; T70		
346140 55	1-Chave soquete Torx 1/2" (140mmL) T55		



Jogo de chave fixa com 11pçs

5111		
Código		6/12.6/13.6/0.8'
754 0607...3032	Conteúdo:	
	11-Chave fixa 6x7; 8x9; 10x11; 12x13; 14x15; 16x17; 18x19; 20x22; 21x23; 24x27; 30x32 mm	



Jogo de martelo e talhadeira com 5pçs

5053		
Código		6/14.5/16.5/0.9'
616300	Conteúdo:	
616400	1-Martelo de pena 300g	
	1-Martelo de borracha 400g	
	3-Talhadeira	
60215180	15mm (180mmL)	
60219180	19mm (180mmL)	
60225220	25mm (220mmL)	





Jogo combinado 65 pçs - catraca 72 dentes

2641			
Código	Soquete	6/15.0/16.0/0.9'	2500g
Composição: 1/4" DR.			
525 032...14	14-Soquete sextavado curto 3.2; 4; 4.5; 5; 5.5; 6; 7; 8; 9; 10; 11; 12; 13; 14 mm		
52550 05...13	9-Soquete sextavado longo 5; 6; 7; 8; 9; 10; 11; 12; 13 mm		
32432 03...10	24-Chave soquete (32mmL) Hexagonal 3; 4; 5; 6; 7; 8; 10 mm		
32132 1...3	Phillips PH.1; PH.2; PH.3		
32232 1...3	Pozidriv PZ.1; PZ.2; PZ.3		
32332 04...065	Fenda 4; 5.5; 6.5 mm		
32632 08...40	Torx T8; T10; T15; T20; T25; T27; T30; T40		
80229	1-Catraca 72 dentes		
8042 050...150	1-Extensões 2"; 4"; 6"		
8032115	1-Cabo de força "T" 115mm		
80521	1-Junta universal		
8143	1-Chave de apoio 6"		
81225	1-Soquete imantado		
5102XLB	1-Jogo de chave "L" hexagonal abaulada com 10pçs 1.27; 1.5; 2; 2.5; 3; 4; 5; 6; 8; 10 mm		
7650127XL...			
10XL			



Jogo de chave com 14pçs

2142		
Código	6/8.4/9.4/1.3'	1490g
Conteúdo:		
713 03B...08B	6-Chave de fenda 3mm(75mmL); 3.5mm(100mmL); 4mm(100mmL); 5.5mm(125mmL); 6.5mm(150mmL); 8mm(175mmL)	
713 055BS...065BS	2-Chave de fenda cotoco 5.5mm(25mmL); 6.5mm(25mmL)	
711 0B...3B	4-Chave Phillips PH.0(60mmL); PH.1(80mmL); PH.2(100mmL); PH.3(150mmL)	
711 1BS...2BS	2-Chave Phillips cotoco PH.1(25mmL); PH.2(25mmL)	



Jogo de martelo e talhadeira com 5pçs

5053		
Código	6/14.5/16.5/0.9'	2415g
Conteúdo:		
616300	1-Martelo de pena 300g	
616400	1-Martelo de borracha 400g	
60215180	3-Talhadeira 15mm (180mmL)	
60219180	19mm (180mmL)	
60225220	25mm (220mmL)	



Jogo de soquete 3/8" com 25pçs

3251-72-5			
Código	Soquete	6/15.0/16.0/0.9'	2500g
Conteúdo: 3/8"DR.			
537 06...22	17-Soquete sextavado 6; 7; 8; 9; 10; 11; 12; 13; 14; 15; 16; 17; 18; 19; 20; 21; 22 mm		
80239	1-Catraca 72 dentes		
8043 075...150	2-Extensão 3"; 6"		
80531	1-Junta universal		
8033165	1-Cabo de força "T"		
8073 16...20.6	2-Chave de vela 16; 20.6 mm		



Jogo de acessórios com 5pçs

4057		
Código	6/15.0/16.0/0.9'	2500g
Conteúdo: 1/2"DR.		
80249	1-Catraca de 72 dentes	
8044 125...250	2-Extensão 5"; 10"	
8034250	1-Cabo de força "T"	
80541	1-Junta universal	

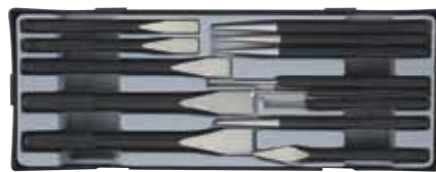

Jogo de saca pino e talhadeira com 13pçs

5131		
Código	6/13.0/14.0/0.9'	2167g
Conteúdo:		
602	5-Talhadeira 10 (150mmL); 12 (150mmL); 15 (180mmL); 19 (200mmL); 22 (200mmL)	
10150...22200	1-Talhadeira tipo bedame - 150mmL	
603150	3-Saca pino 2 (140mmL); 3 (150mmL); 4 (190mm)	
604 2140...4190	3-Punção 2 (185mmL); 3 (185mmL); 4 (185mmL)	
606 2185...4185	1-Punção de centro 4 (185mmL)	
6074185		



Jogo de alicate para anéis com 4pçs

5043A		
Código	6/9.5/10.5.8/0.9'	1800g
Conteúdo:		
609ASO	4-Alicate para anéis Bico reto externo 1.8mm (abre)	
609ASC	Bico reto interno 1.8mm (fecha)	
609ABO	Bico curvo 90" externo 1.8mm (abre)	
609ABC	Bico curvo 90" interno 1.8mm (fecha)	



Jogo de chave combinada com 16pçs

5161		
Código	6/14.0/15.0/0.9'	2333g
Conteúdo:		
755 06...24	16-Chave combinada 6; 7; 8; 9; 10; 11; 12; 13; 14; 15; 16; 17; 18; 19; 22; 24 mm	



Jogo de Torx e estriado 3/8" com 38pçs

3381		
Código	6/14.8/15.8/0.9'	2466g
Conteúdo:		
536 04...16	10-Soquete Torx curto 3/8" E4; E5; E6; E7; E8; E10; E11; E12; E14; E16	
53655 04...16	10-Soquete Torx longo 3/8" E4; E5; E6; E7; E8; E10 E11; E12; E14; E16	
33750 08...60	12-Chave soquete Torx com guia 3/8" T8H; T10H; T15H; T20H; T25H; T27H; T30H; T40H; T45H; T50H T55H; T60H	
33850 05...12	6-Chave soquete estriada 3/8" M5; M6; M8; M9; M10; M12	



Jogo de chave fixa com 11pçs

5111		
Código	6/12.6/13.6/0.8'	2666g
Conteúdo:		
754 0607...3032	11-Chave fixa 6x7; 8x9; 10x11; 12x13; 14x15; 16x17; 18x19; 20x22; 21x23; 24x27; 30x32 mm	

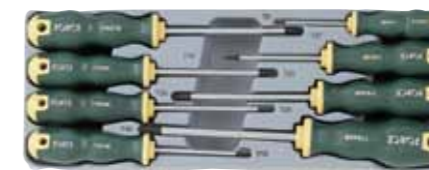

Jogo de chave Torx com 8pçs

2086B			
Código	Torx	10/6.0/7.0/1.1'	600g
Conteúdo:			
716 08B...40B	8-Chave Torx T8; T10; T15; T20; T25; T27; T30; T40		

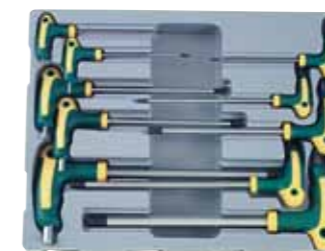

Jogo de chave allen abaulada cabo T com 10pçs

5106B			
Código		6/17.8/18.8/1.3'	2967g
Conteúdo:			
765 02G...12G	10-Chave allen abaulada cabo T 2; 2.5; 3; 4; 5; 6; 7; 8; 10; 12 mm		



Jogo de chave estrela 750. com 8pçs

5081			
Código	Estriado	6/13.0/14.0/0.9'	2166g
Conteúdo:			
759 0607...2123	8-Chave estrela 750. 6x7; 8x9; 10x11; 12x13; 14x15; 16x17; 18x19; 21x23 mm		



Jogo de alicates com 3pçs

5038		
Código	6/12.8/13.8/0.9'	2130g
Conteúdo:		
649250B	1-Chave ajustável/inglesa 10"	
613B250	1-Alicate bomba d'água 10"	
614250	1-Alicate de pressão 10"	



Jogo de alicate com 4pçs

5046		
Código	6/9.9/10.9/0.9'	1650g
Conteúdo:		
610B200	1-Alicate de bico 8"	
610B200B	1-Alicate de bico curvo 8"	
611B175	1-Alicate universal 7"	
612B175	1-Alicate de corte diagonal 7"	



Jogo de chave sextavada cabo T com 9pçs

2095			
Código		6/11.3/12.3/1.8'	1750g
Conteúdo:			
774300 05...13	9-Chave sextavada cabo T 5; 6; 7; 8; 9; 10; 11; 12; 13mm (300mmL)		



Jogo de soquete com 21pçs

4212			
Código	Soquete	6/16.0/17.0/0.9'	2666g
Conteúdo: 1/2"DR.			
545 08...32	21-Soquete sextavado 8; 10; 11; 12; 13; 14; 15; 16; 17; 18; 19; 20; 21; 22; 23; 24; 26; 27; 28; 30; 32 mm		





Bits Phillips - 1/4"

121		<i>l</i>		
Código	Medida	mm	g	pc/cx
121302	PH.2	30	6	10

Bits Hexagonal - 1/4"

124		<i>l</i>		
Código	Medida	mm	g	pc/cx
1242502	2	25	4	10
1242503	3	25	4	10
1242504	4	25	5	10
1242505	5	25	5	10
12425055	5.5	25	5	10
1242506	6	25	5	10
1242507	7	25	6	10
1242508	8	25	6	10
1242510	10	25	8	10
124305.32	5/32"	30	5	10



Bits Torx - 1/4"

126		<i>l</i>		
Código	Medida	mm	g	pc/cx
1262540	T40	25	6	10



Bits Phillips - 5/16"

151		<i>l</i>		
Código	Medida	mm	g	pc/cx
151802	PH.2	80	30	10

Bits Hexagonal

174		<i>l</i>		
Código	Medida	mm	g	pc/cx
1743004	4	30	14	10
1743005	5	30	14	10
1743006	6	30	14	10
1743007	7	30	16	10
1743008	8	30	18	10
1743010	10	30	20	10
1743012	12	30	24	10
1747504	4	75	44	10
1747505	5	75	44	10
1747506	6	75	44	10
1747507	7	75	44	10
1747508	8	75	46	10
1747510	10	75	50	10
1747512	12	75	68	10



Bits Torx

176		<i>l</i>		
Código	Medida	mm	g	pc/cx
1763010	T10	30	14	10
1763015	T15	30	14	10
1763020	T20	30	14	10
1763025	T25	30	14	10
1763027	T27	30	14	10
1763030	T30	30	14	10
1763040	T40	30	14	10
1763045	T45	30	16	10
1763047	T47	30	16	10
1763050	T50	30	16	10
1763055	T55	30	18	10
1763060	T60	30	22	10
1767510	T10	75	42	10
1767515	T15	75	42	10
1767520	T20	75	42	10
1767525	T25	75	42	10
1767527	T27	75	42	10
1767530	T30	75	42	10
1767540	T40	75	44	10
1767545	T45	75	44	10
1767550	T50	75	46	10
1767555	T55	75	48	10
1767560	T60	75	66	10
17611555	T55	115	70	10
17612040	T40	120	72	10
17612045	T45	120	72	10
17612050	T50	120	74	10
17612055	T55	120	74	10



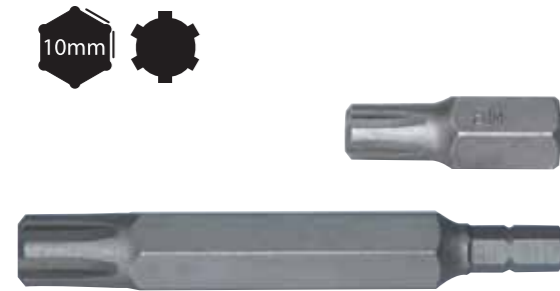

Bits Ribe				
179		<i>l</i>		
Código	Medida	mm	g	pc/cx
1793004	M4	30	14	10
1793005	M5	30	14	10
1793006	M6	30	14	10
1793007	M7	30	14	10
1793008	M8	30	14	10
1793009	M9	30	18	10
1793010	M10	30	18	10
1793012	M12	30	20	10
1793013	M13	30	22	10
1793014	M14	30	24	10
1797504	M4	75	42	10
1797505	M5	75	42	10
1797506	M6	75	42	10
1797507	M7	75	42	10
1797508	M8	75	44	10
1797509	M9	75	46	10
1797510	M10	75	47	10
1797512	M12	75	63	10
1797513	M13	75	78	10
1797514	M14	75	79	10



Bits Multidentado				
178		<i>l</i>		
Código	Medida	mm	g	pc/cx
1783005	M5	30	13	10
1783006	M6	30	14	10
1783008	M8	30	15	10
1783010	M10	30	17	10
1783012	M12	30	20	10
1787505	M5	75	43	10
1787506	M6	75	43	10
1787508	M8	75	44	10
1787510	M10	75	47	10
1787512	M12	75	58	10
17812008	M8	120	74	10
17812010	M10	120	77	10
17812012	M12	120	106	10

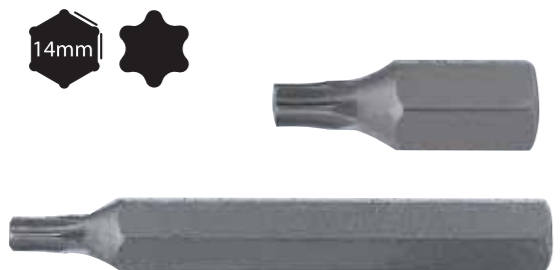
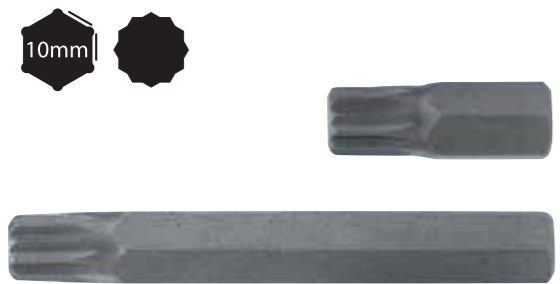

Bits Torx				
196		<i>l</i>		
Código	Medida	mm	g	pc/cx
1965060	T60	50	56	10
1965070	T70	50	58	10
1967560	T60	75	88	10
1967570	T70	75	90	10

Soquete Sextavado Curto - 1/2"

545		<i>l</i>		
Código	Medida	mm	g	pc/cx
54508	8	38	50	10
54509	9	38	50	10
54510	10	38	52	10
54511	11	38	52	10
54512	12	38	53	10
54513	13	38	53	10
54514	14	38	55	10
54515	15	38	55	10
54516	16	38	59	10
54517	17	38	65	10
54518	18	38	78	10
54519	19	38	79	10
54520	20	38	81	10
54521	21	38	95	10
54522	22	38	96	10
54523	23	40	116	10
54524	24	40	117	10
54525	25	43	119	10
54526	26	43	138	10
54527	27	43	144	10
54528	28	43	162	10
54529	29	43	16	10
54530	30	45	54	10
54531	31	45	55	10
54532	32	45	55	10

Soquete Sextavado Longo - 1/2"

54577		<i>l</i>		
Código	Medida	mm	g	pc/cx
5457708	8	77	73	10
5457709	9	77	77	10
5457710	10	77	79	10
5457711	11	77	81	10
5457712	12	77	86	10
5457713	13	77	94	10
5457714	14	77	105	10
5457715	15	77	111	10
5457716	16	77	122	10
5457717	17	77	132	10
5457718	18	77	157	10
5457719	19	77	163	10
5457720	20	77	171	10
5457721	21	77	207	10
5457722	22	77	220	10
5457723	23	77	236	10
5457724	24	77	243	10
5457725	25	77	254	10
5457726	26	77	289	10
5457727	27	77	297	10
5457728	28	77	317	10
5457729	29	77	333	10
5457730	30	77	352	10
5457731	31	77	384	10
5457732	32	77	420	10



Soquete Estriado Curto - 1/2"

549	●	l	g	pc/cx
Código	Medida	mm	g	pc/cx
54908	8	38	51	10
54909	9	38	51	10
54910	10	38	51	10
54911	11	38	52	10
54912	12	38	52	10
54913	13	38	52	10
54914	14	38	54	10
54915	15	38	53	10
54916	16	38	58	10
54917	17	38	64	10
54918	18	38	80	10
54919	19	38	81	10
54920	20	38	86	10
54921	21	38	94	10
54922	22	38	94	10
54923	23	40	108	10
54924	24	40	108	10
54925	25	43	117	10
54926	26	43	124	10
54927	27	43	135	10
54928	28	43	138	10
54929	29	43	165	10
54930	30	45	168	10
54931	31	45	171	10
54932	32	45	176	10

Soquete Estriado Longo - 1/2"

54977	●	l	g	pc/cx
Código	Medida	mm	g	pc/cx
5497708	8	77	70	10
5497709	9	77	75	10
5497710	10	77	75	10
5497711	11	77	78	10
5497712	12	77	84	10
5497713	13	77	97	10
5497714	14	77	99	10
5497715	15	77	100	10
5497716	16	77	113	10
5497717	17	77	125	10
5497718	18	77	160	10
5497719	19	77	164	10
5497720	20	77	167	10
5497721	21	77	213	10
5497722	22	77	220	10
5497723	23	77	227	10
5497724	24	77	234	10
5497725	25	77	244	10
5497726	26	77	268	10
5497727	27	77	281	10
5497728	28	77	295	10
5497729	29	77	309	10
5497730	30	77	352	10
5497731	31	77	384	10
5497732	32	77	420	10

Soquete Torx Curto - 1/2"

546	●	l	g	pc/cx
Medida	mm	g	pc/cx	
54608	E8	38	50	10
54610	E10	38	52	10
54611	E11	38	52	10
54612	E12	38	53	10
54614	E14	38	55	10
54616	E16	38	57	10
54618	E18	38	59	10
54620	E20	38	64	10
54622	E22	38	85	10
54624	E24	40	100	10

Soquete Torx Longo - 1/2"

54677	●	l	g	pc/cx
Código	Medida	mm	g	pc/cx
5467708	E08	77	80	10
5467710	E10	77	84	10
5467711	E11	77	88	10
5467712	E12	77	93	10
5467714	E14	77	98	10
5467716	E16	77	119	10
5467718	E18	77	129	10
5467720	E20	77	171	10
5467724	E24	77	227	10

Soquete Surface longo - 1/2"

54777	●	l	g	pc/cx
Código	Soquete	mm	g	pc/cx
5477708	8	77	73	10
5477709	9	77	77	10
5477710	10	77	79	10
5477711	11	77	81	10
5477712	12	77	86	10
5477713	13	77	94	10
5477714	14	77	105	10
5477715	15	77	111	10
5477716	16	77	122	10
5477717	17	77	132	10
5477718	18	77	157	10
5477719	19	77	163	10
5477720	20	77	171	10
5477721	21	77	207	10
5477722	22	77	220	10
5477723	23	77	236	10
5477724	24	77	243	10





Soquete Spline Curto - 1/2"

54Q							<i>l</i>		
Código	Medida	Sextavado	Estriado	SAE	E-Tox	XZN	mm	g	pc/cx
54Q08	8	□	□		E10		38	44	10
54Q09	9	□	□		E11		38	44	10
54Q10	10	□	□	3/8"	E12	10	38	46	10
54Q11	11	□	□	7/16"	E14	11	38	46	10
54Q12	12	□	□	15/32"		12	38	48	10
54Q13	13	□	□	1/2"	E16		38	50	10
54Q14	14	□	□	9/16"	E18	14	38	52	10
54Q15	15	□	□	19/32"			38	56	10
54Q16	16	□	□	5/8"	E20	16	38	58	10
54Q17	17	□	□				38	72	10
54Q18	18	□	□		E22	18	38	78	10
54Q19	19	□	□	3/4"	E24		38	80	10
54Q20	20	□	□	25/32"		20	38	82	10
54Q21	21	□	□	13/16"			38	82	10
54Q22	22	□	□	7/8"		22	38	86	10
54Q23	23	□	□				40	100	10
54Q24	24	□	□	15/16"		24	40	112	10
54Q26	26	□	□				43	140	10
54Q27	27	□	□	1-1/16"			43	170	10
54Q28	28	□	□				43	180	10
54Q30	30	□	□	1-1/8"		30	45	210	10
54Q32	32	□	□	1-1/4"		32	45	230	10

Soquete Spline Longo - 1/2"

54Q77							<i>l</i>		
Código	Medida	Sextavado	Estriado	SAE	E-Tox	XZN	mm	g	pc/cx
54Q7708	8	□	□		E10		77	100	10
54Q7709	9	□	□		E11		77	100	10
54Q7710	10	□	□	3/8"	E12	10	77	100	10
54Q7711	11	□	□	7/16"	E14	11	77	103	10
54Q7712	12	□	□	15/32"		12	77	105	10
54Q7713	13	□	□	1/2"	E16		77	107	10
54Q7714	14	□	□	9/16"	E18	14	77	118	10
54Q7715	15	□	□	19/32"			77	125	10
54Q7716	16	□	□	5/8"	E20	16	77	140	10
54Q7717	17	□	□				77	150	10
54Q7718	18	□	□		E22	18	77	165	10
54Q7719	19	□	□	3/4"	E24		77	178	10
54Q7720	20	□	□	25/32"		20	77	180	10
54Q7721	21	□	□	13/16"			77	185	10
54Q7722	22	□	□	7/8"		22	77	205	10
54Q7723	23	□	□				77	245	10
54Q7724	24	□	□	15/16"		24	77	252	10
54Q7726	26	□	□				77	310	10
54Q7727	27	□	□	1-1/16"			77	345	10
54Q7728	28	□	□				77	365	10
54Q7730	30	□	□	1-1/8"		30	77	400	10
54Q7732	32	□	□	1-1/4"		32	77	410	10



Soquete Sextavado Curto - 3/4"

565		<i>l</i>		
Código	Medida	mm	g	pc/cx
56519	19	36	210	2
56520	20	36	210	2
56521	21	36	210	2
56522	22	36	210	2
56523	23	36	210	2
56524	24	36	210	2
56525	25	36	210	2
56526	26	36	210	2
56527	27	36	210	2
56528	28	38	230	2
56529	29	38	240	2
56530	30	38	260	2
56532	32	38	280	2
56533	33	38	310	2
56535	35	42	360	2
56536	36	42	400	2
56538	38	45	450	2
56540	40	45	500	2
56541	41	45	540	2
56542	42	45	580	2
56546	46	48	650	2
56550	50	48	780	2
56554	54	48	900	2
56555	55	48	950	2
56560	60	48	1000	2



Soquete Estriado Curto - 3/4"

569		<i>l</i>		
Código	Medida	mm	g	pc/cx
56919	19	36	210	2
56921	21	36	210	2
56922	22	36	210	2
56923	23	36	210	2
56924	24	36	210	2
56925	25	36	210	2
56926	26	36	210	2
56927	27	36	230	2
56928	28	38	240	2
56929	29	38	260	2
56930	30	38	280	2
56931	31	38	290	2
56932	32	38	300	2
56933	33	38	330	2
56934	34	42	350	2
56935	35	42	370	2
56936	36	42	420	2
56938	38	45	470	2
56941	41	45	550	2
56946	46	48	710	2
56950	50	48	820	2
56955	55	48	980	2
56956	56	48	1000	2
56960	60	48	1050	2
56965	65	48	1200	2



Soquete de Impacto Sextavado Curto 1/2"

445		<i>l</i>		
Código	Medida	mm	g	pc/cx
44508	8	38	71	10
44509	9	38	71	10
44510	10	38	72	10
44511	11	38	72	10
44512	12	38	74	10
44513	13	38	77	10
44514	14	38	80	10
44515	15	38	82	10
44516	16	38	85	10
44517	17	38	89	10
44518	18	38	89	10
44519	19	38	102	10
44520	20	38	124	10
44521	21	38	124	10
44522	22	43	148	10
44523	23	43	148	10
44524	24	43	154	10
44525	25	43	160	10
44526	26	43	181	10
44527	27	43	181	10
44528	28	45	197	10
44529	29	45	200	10
44530	30	45	218	10
44531	31	45	218	10
44532	32	45	218	10
44533	33	46	223	10

Soquete de Impacto Sextavado Longo 1/2"

44585		<i>l</i>		
Código	Medida	mm	g	pc/cx
4458508	8	85	110	10
4458509	9	85	120	10
4458510	10	85	120	10
4458511	11	85	135	10
4458512	12	85	147	10
4458513	13	85	154	10
4458514	14	85	178	10
4458515	15	85	181	10
4458516	16	85	204	10
4458517	17	85	209	10
4458518	18	85	215	10
4458519	19	85	242	10
4458520	20	85	277	10
4458521	21	85	279	10
4458522	22	85	299	10
4458523	23	85	299	10
4458524	24	85	336	10
4458525	25	85	366	10
4458526	26	85	367	10
4458527	27	85	367	10
4458528	28	85	377	10
4458529	29	85	393	10
4458530	30	85	400	10
4458531	31	85	405	10
4458532	32	85	458	10
4458533	33	85	466	10
4458534	34	85	475	10
4458535	35	85	489	10
4458536	36	85	499	10
4458538	38	85	518	5
4458541	41	85	545	5

Chave Soquete Hexagonal - 1/2"

344		<i>l</i>		
Código	Medida	mm	g	pc/cx
34405504	4	55	62	10
34405505	5	55	64	10
34405506	6	55	65	10
34405507	7	55	68	10
34405508	8	55	69	10
34405509	9	55	79	10
34405510	10	55	80	10
34405512	12	55	103	10
34406514	14	65	149	10
34407017	17	70	196	10
34407019	19	70	235	10
34410005	5	100	78	10
34410006	6	100	78	10
34410007	7	100	87	10
34410008	8	100	88	10
34410010	10	100	108	10
34410011	11	100	144	10
34410012	12	100	145	10
34410013	13	100	148	10
34410014	14	100	197	10

Chave Soquete Multidentada - 1/2"

348		<i>l</i>		
Código	Medida	mm	g	pc/cx
34805505	M5	55	67	10
34805506	M6	55	67	10
34805508	M8	55	67	10
34805509	M9	55	77	10
34805510	M10	55	78	10
34805512	M12	55	100	10
34805514	M14	55	131	10
34805516	M16	55	162	10
34810005	M5	100	80	10
34810006	M6	100	85	10
34810008	M8	100	87	10
34810009	M9	100	95	10
34810010	M10	100	108	10
34810012	M12	100	151	10
34810014	M14	100	187	10
34810016	M16	100	242	10
34811010R	M10	110	121	10
34812008	M8	120	95	10
34812009	M9	120	121	10
34812010	M10	120	121	10
34814008	M8	140	110	10
34814009	M9	140	140	10
34814010	M10	140	140	10
34814012	M12	140	152	10
34814014	M14	140	256	10



Soquete de Impacto Sextavado Médio 1/2"

44552		<i>l</i>		
Código	Medida	mm	g	pc/cx
4455214	14	52	100	10
4455217	17	52	125	10
4455219	19	52	142	10
4455221	21	52	161	10
4455223	23	52	174	10
4455224	24	52	185	10



1/2"



Chave Soquete Tipo Torx - 1/2"

346		<i>l</i>		
Código	Medida	mm	g	pc/cx
34605520	T20	55	62	10
34605525	T25	55	63	10
34605527	T27	55	63	10
34605530	T30	55	63	10
34605535	T35	55	63	10
34605540	T40	55	64	10
34605545	T45	55	67	10
34605547	T47	55	67	10
34605550	T50	55	68	10
34605555	T55	55	79	10
34605560	T60	55	101	10
34605570	T70	55	132	10
34607080	T80	70	185	10
34610020	T20	100	74	10
34610025	T25	100	74	10
34610027	T27	100	75	10
34610030	T30	100	76	10
34610040	T40	100	76	10
34610045	T45	100	86	10
34610050	T50	100	87	10
34610055	T55	100	108	10
34610060	T60	100	146	10
34610070	T70	100	191	10
34610080	T80	100	246	10
34610090	T90	100	299	5
346100100	T100	100	350	5
34612040	T40	120	90	10
34612045	T45	120	100	10
34612070	T70	120	211	10
34614045	T45	140	103	10
34614050	T50	140	104	10
34614055	T55	140	138	10
34614060	T60	140	184	10
34614070	T70	140	198	10
34614090	T90	140	233	10
346140100	T100	140	241	10
34620030	T30	200	110	10
34620040	T40	200	110	10
34620045	T45	200	135	10
34620050	T50	200	138	10



Chave Soquete Tipo Ribe - 1/2"

349		<i>l</i>		
Código	Medida	mm	g	pc/cx
34910005	M5	100	82	10
34910006	M6	100	82	10
34910007	M7	100	82	10
34910008	M8	100	82	10
34910009	M9	100	106	10
34910010	M10	100	122	10
34910012	M12	100	150	10
34910013	M13	100	185	10
34910014	M14	100	187	10
34910016	M16	100	237	10
34912009	M9	120	148	10
34914008	M8	140	102	10
34914010	M10	140	136	10
34914012	M12	140	178	10
34914014	M14	140	286	10



Chave Soquete Torx de impacto - 1/2"

246060		<i>l</i>		
Part no.	size	mm	g	pc/box
24606030	T30	60	63	10
24606040	T40	60	67	10
24606045	T45	60	71	10
24606050	T50	60	74	10
24606055	T55	60	88	10



Chave Soquete Tipo Ribe para cabeçote Linha AUDI

349..V		<i>l</i>		
Código	Medida	mm	g	pc/cx
34914010V	M10S	140	136	10



Chave Soquete Multidentada com Guia

348..T		<i>l</i>		
Código	Medida	mm	g	pc/cx
34805516T	M16	55	161	10



Chave Soquete Hexagonal - 1/4"

324		<i>l</i>		
Código	Medida	mm	g	pc/cx
3243204	4	32	14	50



Chave Soquete Torx - 1/4"

326		<i>l</i>		
Código	Medida	mm	g	pc/cx
3263230	T30	32	14	50

Jogo de soquete Torx longo com 6 pçs

2062			
Código	Soquete	60/10.2/11.2/1.5'	180g
52650 04...10	Composição: 1/4" DR. 6- Soquete Torx longo E4; E5; E6; E7; E8; E10 (50mmL)		

Jogo de soquete Torx curto com 6 pçs

2062S			
Código	Soquete	60/10.2/11.2/1.5'	180g
526 04...10	Composição: 1/4" DR. 6- Soquete Torx curto E4; E5; E6; E7; E8; E10 (25mmL)		

Jogo de bits Torx com guia - 8 pçs

2081			
Código	Bit	100/14.0/15.0/1.5'	140g
12730 10G...40G 8152105	Composição: 1/4" 7-Bits Torx com guia (30mmL) T-10H; T-15H; T-20H; T-25H; T-27H; T-30H; T-40H 1-Adaptador de bits 1/4" em "L"		

Jogo de soquete Sextavado longo com 11 pçs

21115			
Código	Soquete	48/17.8/18.8/1.4'	370g
52550 04...14	Composição: 1/4" DR. 11-Soquete Sextavado longo 4; 5; 6; 7; 8; 9; 10; 11; 12; 13; 14 mm		

Jogo de soquete Sextavado com 13 pçs

2133-5			
Código	Soquete	48/12.0/13.0/1.4'	270g
525 04...14	Composição: 1/4" DR. 13-Soquete Sextavado curto 4; 4.5; 5; 5.5; 6; 7; 8; 9; 10; 11; 12; 13; 14 mm		

Jogo de soquete Spline longo com 13 pçs

2138Q			
Código	Soquete	48/21.0/22.0/1.2'	438g
52Q50 04...14	Composição: 1/4" DR. 13- Soquete Spline longo 1/4" (50mmL) 4; 4.5; 5; 5.5; 6; 7; 8; 9; 10; 11; 12; 13; 14 mm		

Jogo de soquete Spline curto com 14 pçs

2144Q			
Código	Soquete	48/11.0/12.0/1.1'	230g
52Q 032...14	Composição: 1/4" DR. 14- Soquete Spline curto 1/4" 3.2; 4; 4.5; 5; 5.5; 6; 7; 8; 9; 10; 11; 12; 13; 14 mm		

Jogo de soquete Sextavado com 19 pçs

2203-5			
Código	Soquete	15/14.0/15.0/1'	934g
525 04...14 80222 8042 050...150 80521 8032115 8145	Composição: 1/4" DR. 13-Soquete Sextavado curto 4; 4.5; 5; 5.5; 6; 7; 8; 9; 10; 11; 12; 13; 14 mm 1-Catraca 2-Extensões 2"; 6" 1-Junta universal 1-Cabo de força "T" 115mm 1-Chave de apoio 6"		

Jogo de soquete sextavado com 24 pçs

2253-72			
Código	Soquete	15/19.3/20.3/1'	1287g
525 04...13 52550 05...13 80229 8042 050...150 8143	Composição: 1/4" DR. 11-Soquete sextavado curto 4; 5; 5.5; 6; 7; 8; 9; 10; 11; 12; 13 mm 9-Soquete sextavado longo 5; 6; 7; 8; 9; 10; 11; 12; 13 mm 1-Catraca 72 destes 2-Extensão 2"; 6" 1-Chave de apoio 6"		





Jogo combinado estriado com 27 pçs

2281			
Código	Soquete	15/17.3/18.3/1'	1154g
529 04...14	Composição: 1/4" DR. 11-Soquete estriado 4; 5; 6; 7; 8; 9; 10; 11; 12; 13; 14 mm		
32432 03...06	10-Chave soquete (32mmL) Hexagonal 3; 4; 5; 6 mm		
32332 04...07	Fenda 4; 5.5; 7 mm		
32132 1...3	Phillips PH.1; PH.2; PH.3		
80222	1-Catraca		
8042 050...150	2-Extensão 2"; 6"		
8032115	1-Cabo de força "T" 115mm		
80521	1-Junta universal		
8143	1-Chave de apoio 6"		

Jogo de bits com 31 pçs - 1/4"

2313		
Código	48/14.4/15.4/1.2'	300g
12125 0...3	Composição: 1/4" 6-1/4" bits Phillips (25mmL) PH.0 x 1pc; PH.1 x 2pc; PH.2 x 2pc; PH.3 x 1pc	
12225 1...3	5-1/4" bits Pozidriv (25mmL) PZ.1 x 2pc; PZ.2 x 2pc; PZ.3 x 1pc	
12325 055...065	3-1/4" bits Fenda 4; 5.5; 6.5 mm (25mmL)	
12425 03...06	4-1/4" bits Hexagonal 3; 4; 5; 6 mm (25mmL)	
12625 05...40	12-1/4" bits Torx T5; T6; T7; T8; T9; T10; T15; T20; T25; T27; T30; T40 (25mmL)	
81260Q	1-Adaptador magnético para bits 1/4" com sistema engate rápido	

Jogo de bits com 33pçs - 1/4"

2331		
Código	80/20.0/21.0/1.6'	250g
81260	1-Adaptador magnético para bits (60mmL)	
121S25 06...10	32-Bits 1/4" (25mmL)	
122S25 01...04	Torq set 6; 8; 10	
123S25 04...10	Tri-wing 1; 2; 3; 4	
124S25 02...06	Spanner 4; 6; 8; 10	
124S25 5.32...5.64	Hexagonal 2; 2.5; 3; 4; 5; 6 mm 5/32"; 9/64"; 1/8"; 7/64"; 3/32"; 5/64"	
12725 08...40	Torx com guia T-8H; T-10H; T-15H; T-20H; T-25H; T-27H; T-30H; T-35H; T-40H	

Jogo combinado Spline com 40 pçs

2405Q			
Código	Soquete	15/14.5/15.5/1'	967g
52Q 02...14	Composição: 1/4" DR. 13-Soquete Spline curto 4; 4.5; 5; 5.5; 6; 7; 8; 9; 10; 11; 12; 13; 14 mm		
12125 1...2	22-Bits 1/4" (25mmL) Phillips PH.1; PH.2		
12225 1...2	Pozidriv PZ.1; PZ.2		
12425 03...08	Hexagonal 3; 4; 5; 6; 7; 8 mm		
12625 10...40	Torx T10; T15; T20; T25; T27; T30; T40		
12825 04...10	Multidentado M4; M5; M6; M8; M10		
80222	1-Catraca		
8042100	1-Extensão (100mmL)		
80521	1-Junta universal		
81022	1-Adaptador para bits 1/4"(F)x1/4"(F)		
8143	1-Chave de apoio 6"		

Jogo combinado com 74pçs - 1/4"

2742-18			
Código	Soquete	6/12.7/13.7/0.9'	1580g
525 04...13	Composição: 1/4" DR. 12-Soquete sextavado curto 4; 4.5; 5; 5.5; 6; 7; 8; 9; 10; 11; 12; 13 mm		
52550 04...13	12-Soquete sextavado longo 4; 4.5; 5; 5.5; 6; 7; 8; 9; 10; 11; 12; 13 mm		
526 04...10	6-Soquete Torx curto E4; E5; E6; E7; E8; E10		
52650 04...10	6-Soquete Torx longo E4; E5; E6; E7; E8; E10		
32432 03...10	32-Chave soquete (32mmL) Hexagonal 3; 4; 5; 6; 7; 8; 10 mm		
32132 0...2	Phillips PH.0; PH.1; PH.2		
32232 0...2	Pozidriv PZ.0; PZ.1; PZ.2		
32332 04...065	Fenda 4; 5.5; 6.5 mm		
32632 08...40	Torx T8; T10; T15; T20; T25; T27; T30; T40		
32732 08...40	Torx com guia T-8H; T-10H; T-15H; T-20H; T-25H; T-27H; T-30H; T-40H		
802218	1-Catraca articulada		
8042 050...150	3-Extensões 2"; 4"; 6"		
80521	1-Junta universal		
81225	1-Soquete magnético		

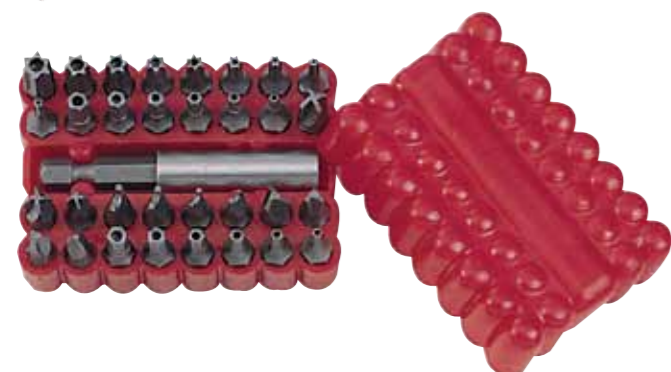



Jogo combinado 42 pçs - catraca 72 dentes

2421	Soquete	20/18.0/19.0/0.82	900g
Código	Soquete	20/18.0/19.0/0.82	900g
Composição: 1/4" DR.			
525 032...14	14-Soquete sextavado curto	3.2; 4; 4.5; 5; 5.5; 6; 7; 8; 9; 10; 11; 12; 13; 14 mm	
	20-Bits 1/4" (25mmL)		
12425 03...08	Hexagonal 3, 4, 5, 6, 8 mm		
12625 10...40	Torx T10, T15, T20, T25, T30, T40		
12325 04...065	Fenda 4, 5.5, 6.5 mm		
12125 1...3	Phillips PH.1, PH.2, PH.3		
12225 1...3	Pozidriv PZ.1, PZ.2, PZ.3		
80229	1-Catraca 72 dentes		
8042 050...150	2-Extensões 2"; 6"		
80521	1-Junta universal		
81022	1-Adaptador para bits 1/4"(F)x1/4"(F)		
8143	1-Chave de apoio 6"		
80632	1-Adaptador para extensão 3/8"(F)x1/4"(M)		
81225	1-Soquete imantado		

Jogo combinado 64 pçs - catraca 72 dentes

2641	Soquete	6/15.0/16.0/0.9'	2500g
Código	Soquete	6/15.0/16.0/0.9'	2500g
Composição: 1/4" DR.			
525 032...14	14-Soquete sextavado curto	3.2; 4; 4.5; 5; 5.5; 6; 7; 8; 9; 10; 11; 12; 13; 14 mm	
52550 05...13	9-Soquete sextavado longo	5; 6; 7; 8; 9; 10; 11; 12; 13 mm	
	24-Chave soquete (32mmL)		
32432 03...10	Hexagonal 3; 4; 5; 6; 7; 8; 10 mm		
32132 1...3	Phillips PH.1; PH.2; PH.3		
32232 1...3	Pozidriv PZ.1; PZ.2; PZ.3		
32332 04...065	Fenda 4; 5.5; 6.5 mm		
32632 08...40	Torx T8; T10; T15; T20; T25; T27; T30; T40		
80229	1-Catraca 72 dentes		
8042 050...150	1-Extensões 2"; 4"; 6"		
8032115	1-Cabo de força "T" 115mm		
80521	1-Junta universal		
8143	1-Chave de apoio 6"		
81225	1-Soquete imantado		
5102XLB	1-Jogo de chave "L" hexagonal abaulada com 10pçs		
7650127XL...10XL		1.27; 1.5; 2; 2.5; 3; 4; 5; 6; 8; 10 mm	

Jogo de chave de apoio com catraca com 25pçs - 1/4"

2255	Soquete	40/15.6/16.6/3.2'	370g
Código	Soquete	40/15.6/16.6/3.2'	370g
Composição: 1/4" DR.			
81022M	1-Adaptador magnético para bit de 1/4"		
8149	1-Chave de apoio com catraca		
23-Bits de 1/4" (25mmL)			
12125 1...3	Phillips PH.1; PH.2; PH.3		
12225 1...3	Pozidriv PZ.1; PZ.2; PZ.3		
12325 03...065	Fenda 3; 4; 5; 5.5; 6.5 mm		
12425 03...08	Hexagonal 3; 4; 5; 6; 7; 8 mm		
12725 10...30	Torx com guia T-10H; T-15H; T-20H T-25H; T-27H; T-30H		



Jogo de chave de apoio com catraca com 26pçs - 1/4"

2263	Soquete	10/14.0/15.0/1'	370g
Código	Soquete	10/14.0/15.0/1'	370g
Composição: 1/4" DR.			
12-Bits duplo de 1/4" (165mm)			
121D 12...34	Phillips PH.1xPH.2; PH.3xPH.4		
122D 12...34	Pozidriv PZ.1xPZ.2; PZ.3xPZ.4		
123D 0304...05507	Fenda 3x4mm; 5.5x7mm		
124D 0304...0506	Hexagonal 3x4mm; 5x6mm		
126D 0810...3040	Torx T8xT10; T15xT20; T25xT27; T30xT40		
525 04...12	11-Soquete sextavado de 1/4" 4; 4.5; 5; 5.5; 6; 7; 8; 9; 10; 11; 12mm		
80922	1-Adaptador para bits 1/4"		
8152R	1-Cabo com catraca para bits		
88601	1-Desmagnetizador/Magnetizador		



Jogo de chave de vela com catraca

3051	Soquete	20/17.5/18.5/1.3'	875g
Código	Soquete	20/17.5/18.5/1.3'	875g
Composição: 3/8" DR.			
802313	1-Catraca articulada		
8073 16...20.6	2-Chave de vela 16; 20.6 mm		
8043 044...075	2-Extensões 44; 75 mm		



Jogo de chave soquete Ribe com 7pçs

3078	Bits	20/20.0/21.0/1.2'	1000g
Código	Bits	20/20.0/21.0/1.2'	1000g
Composição: 3/8" & 1/2" DR.			
339090 06...10	4-Chave soquete Ribe 3/8" (90mmL) M6; M7; M8; M10		
349100 12...14	3-Chave soquete Ribe 1/2" (100mmL) M12; M13; M14		





Jogo de soquete longo com 12pçs - 3/8"

3121			
Código	Soquete	6/7.2/8.2/0.9'	1200g
53563 08...22	Composição:3/8"DR. 12-Soquete sextavado longo (63mmL) 8; 10; 11; 12; 13; 14; 15; 16; 17; 18; 19; 22 mm		



Jogo de soquete sextavado 23 pçs - catraca 72 dentes

3232			
Código	Soquete	10/18.8/19.8/1'	1880g
535 06...22	Composição:3/8"DR. 17-Soquete sextavado 6; 7; 8; 9; 10; 11; 12; 13; 14; 15; 16; 17; 18; 19; 20; 21; 22 mm		
80239	1-Catraca 72 dentes		
8043 075...225	3-Extensões 3"; 6"; 9"		
80531	1-Junta universal		
80643	1-Adaptador para extensão 1/2"(F)x3/8"(M)		



Jogo combinado 45pçs - 3/8"

3451			
Código	Soquete	4/20.2/21.2/0.9'	5050g
535 08...22	Composição:3/8"DR. 15-Soquete sextavado curto (MM) 8; 9; 10; 11; 12; 13; 14; 15; 16; 17; 18; 19; 20; 21; 22 mm		
53563 08...22	11-Soquete sextavado longo (MM) 8; 9; 10; 11; 12; 13; 14; 16; 17; 19; 22 mm		
535 3.8...13.16	5-Soquete sextavado curto (SAE) 3/8"; 1/2"; 9/16"; 11/16"; 13/16"		
53563 3.8...13.16	5-Soquete sextavado longo (SAE) 3/8"; 1/2"; 9/16"; 11/16"; 13/16"		
8073 16...20.6	3-Chave de vela 16; 18; 20.6 mm		
802311	1-Catraca		
8013200B	1-Cabo articulado curvo		
8043 075...150	2-Extensões 3"; 6"		
80643	1-Adaptador para extensão 1/2"(F)x3/8"(M)		
80531	1-Junta universal		



Jogo de soquete Torx longo com 5 pçs

40511			
Código	Soquete	12/13.5/14.5/1'	1125g
54677 10...18	Composição: 1/2"DR. 8-Soquete Torx longo (77mmL) E10; E12; E14; E16; E18;		



Jogo de chave soquete Torx com 6 pçs

4062L			
Código	Bits	25/15.8/16.8/0.64'	632g
346055 25...55	Composição: 1/2"DR. 6-Chave soquete Torx (55mmL) T25; T30; T40; T45; T50; T55		



Jogo de soquete estriado longo com 7pçs

40711-9			
Código	Soquete	12/16.1/17.1/1'	1340g
54977 08...19	Composição: 1/2"DR. 7-Soquete estriado longo 8; 10; 12; 13; 14; 17; 19 mm		



Jogo de bits Torx 10mm com 8 pçs 10mm

4081			
Código	Bit	100/19.0/20.0/1.6'	190g
17630 20...55	Composição: 1/2"DR. 7-10mm bits Torx(30mmL) T20; T25; T30; T40; T45; T50; T55		
81047	1-Adaptador para bits 1/2"DR.x10mm		



Jogo de soquete sextavado longo com 8 pçs (MM)

4082A			
Código	Soquete	12/17.3/18.3/1'	1440g
54577 10...19	Composição: 1/2"DR. 8-Soquete sextavado longo (77mmL) 10; 13; 14; 15; 16; 17; 18; 19		



Jogo de chave soquete hexagonal com 8 pçs (MM)

4091			
Código	Bits	20/22.5/23.5/0.82'	1125g
344055 05...12	Composição: 1/2"DR. 8-Chave soquete hexagonal 5; 6; 7; 8; 10; 12 mm (55mmL)		
34406514	14 mm (65mmL)		
34407017	17 mm (70mmL)		

Jogo de soquete sextavado longo com 9pçs

40911			
Código	Soquete	12/17.3/18.3/1'	1440g
54577 10...24	Composição: 1/2"DR. 9-Soquete sextavado longo 10; 12; 13; 14; 17; 19; 21; 22; 24 mm		

Jogo de soquete estriado longo com 9pçs

40911-9			
Código	Soquete	12/17.3/18.3/1'	1440g
54977 10...24	Composição: 1/2"DR. 9-Soquete estriado longo 10; 12; 13; 14; 17; 19; 21; 22; 24 mm		

Jogo de soquete Torx com 9 pçs

4093			
Código	Soquete	20/24.0/25.0/1.1'	1200g
546 10...24	Composição: 1/2"DR. 9-Soquete Torx curto E8; E10; E11; E12; E14; E16; E18; E20; E24		

Jogo de chave soquete Torx com 9 pçs

4102			
Código	Bits	20/22.0/23.0/0.82'	1100g
346055 20...60	Composição: 1/2"DR. 9-Chave soquete Torx T20; T25; T27; T30; T40; T45; T50; T55; T60 (55mmL)		

Jogo de soquete de impacto extra longo com 10 pçs (MM)

4107			
Código	Soquete	10/16.9/27.9/0.7'	2690g
44585 11...24	Composição: 1/2"DR. 10-Soquete de impacto extra longo 11; 12; 13; 14; 16; 17; 19; 21; 22; 24 mm		

Jogo de soquete de impacto curto com 10 pçs (MM)

4109			
Código	Soquete	20/25.0/26.0/0.6'	1250g
445 11...24	Composição: 1/2"DR. 10-Soquete de impacto curto 11; 12; 13; 14; 16; 17; 19; 21; 22; 24 mm		

Jogo de bits multidentado 10mm com 11 pçs

4112			
Código	Bits	20/10.3/11.3/0.82'	515g
17830 05...12	Composição: 1/2"DR. 10-Bits multidentado 10mm M5; M6; M8; M10; M12 (30mmL)		
17875 05...12	M5; M6; M8; M10; M12 (75mmL)		
81047	1-Adaptador para bits 1/2"DR.x10mm		

Jogo de chave soquete com 12pçs

4122			
Código		6/13.0/14.0/0.9'	2160g
34418005	Composição: 1/2"DR. 4-Chave soquete hexagonal 5mm (180mmL)		
344100 06...08	6; 7; 8 mm (100mmL)		
346120 40...45	4-Chave soquete Torx T40; T45 (120mmL)		
346140 55...70	T55; T70 (140mmL)		
348100 06...12	4-Chave soquete multidentada M6; M8; M10; M12 (100mmL)		

Jogo de soquete Spline curto com 12 pçs

4124Q			
Código	Soquete	36/29.0/30.0/1.6'	806g
54Q 10...24	Composição: 1/2"DR. 12-Soquete Spline curto 10; 11; 12; 13; 14; 15; 16; 17; 19; 21; 22; 24 mm		





Jogo de bits hexagonal 10mm com 15 pçs			
4155			
Código	Bits	20/16.0/17.0/0.82'	800g
17430 04...12	Composição: 1/2"DR. 14-Bits hexagonal 10mm 4; 5; 6; 7; 8; 10; 12 mm (30mmL)		
17475 04...12	4; 5; 6; 7; 8; 10; 12 mm (75mmL)		
81047	1-Adaptador para bits 1/2"DR.x10mm		



Jogo de bits Torx 10mm com 15 pçs			
4156			
Código	Bits	20/16.0/17.0/0.82'	800g
17630 20...55	Composição: 1/2"DR. 7-Bits Torx 10mm curto (30mmL) T20; T25; T30; T40; T45; T50; T55		
17675 20...55	7-Bits Torx 10mm longo (75mmL) T20; T25; T30; T40; T45; T50; T55		
81047	1-Adaptador para bits 1/2"DR.x10mm		



Jogo de soquete e chave soquete Torx com 16 pçs			
4171			
Código	Bits	10/20.0/21.0/0.7'	2000g
546 10...24	Composição: 1/2"DR. 9-Soquete Torx E10; E11; E12; E14; E16; E18; E20; E22; E24		
346055 30...70	7-Chave soquete Torx (55mmL) T30; T40; T45; T50; T55; T60; T70		



Jogo de soquete sextavado com 17 pçs (MM)			
4173-5			
Código	Soquete	6/16.0/17.0/0.7'	2660g
545 08...26	Composição: 1/2"DR. 13-Soquete sextavado 8; 10; 11; 12; 13; 14; 15; 16; 17; 19; 21; 23; 26 mm		
80243	1-Catraca		
80541	1-Junta universal		
8034250	1-Cabo de força "T" 1/2"		
8044125	1-Extensão 5"		



Jogo de bits Ribe 10mm com 22 pçs			
4225			
Código	Bits	15/18.2/19.2/1'	1230g
17930 04...14	Composição: 3/8" & 1/2"DR. 20-Bits Ribe 10mm M4; M5; M6; M7; M8; M9; M10; M12; M13; M14 (30mmL)		
17975 04...14	M4; M5; M6; M7; M8; M9; M10; M12; M13; M14 (75mmL)		
810 37...47	2-Adaptador para bits 3/8"DR.x10mm; 1/2"DR.x10mm		

Jogo de soquete sextavado com 22 pçs

4223			
Código	Soquete	5/19.3/20.3/1.4'	3860g
545 10...32	Composição: 1/2"DR. 15-Soquete sextavado 10; 11; 12; 13; 14; 15; 16; 17; 18; 19; 22; 24; 27; 30; 32 mm		
80243	1-Catraca		
8044 125...250	2-Extensão 5" ; 10"		
8074 16...20.6	2-Chave de vela 16 ; 20.6 mm		
80541	1-Junta universal		
80634	1-Adaptador para extensão 3/8"(F)x1/2"(M)		

Jogo de soquete estriado com 22 pçs

4223-9			
Código	Soquete	5/19.3/20.3/1.4'	3860g
549 10...32	Itens que mudam: 15-Soquete estriado 10; 11; 12; 13; 14; 15; 16; 17; 18; 19; 22; 24; 27; 30; 32 mm		

Jogo de soquete sextavado com 24 pçs



4245B			
Código	Soquete	4/20.7/21.7/0.9'	5175g
549 10...32	Composição: 1/2"DR. 18-Soquete sextavado 10; 11; 12; 13; 14; 15; 16; 17; 18; 19; 20; 21; 22; 23; 24; 27; 30; 32 mm		
80244	1-Catraca		
8034250	1-Cabo de força "T" 1/2"		
8044 125...250	2-Extensões 5" ; 10"		
80541	1-Junta universal		
8014380	1-Cabo articulado 15"		



Jogo de soquete estriado com 24 pçs

4245B-9			
Código	Soquete	4/20.7/21.7/0.9'	5175g
549 10...32	Itens que mudam: 18-Soquete estriado 10; 11; 12; 13; 14; 15; 16; 17; 18; 19; 20; 21; 22; 23; 24; 27; 30; 32 mm		









Jogo de bits com 42 pçs			
4421			
Código	10/21.0/22.0/0.7'	2100g	
Composição: 3/8" & 1/2"DR.			
14-Bits hexagonal 10mm			
17430 04...12	4; 5; 6; 7; 8; 10; 12 mm (30mmL)		
17475 04...12	4; 5; 6; 7; 8; 10; 12 mm (75mmL)		
16-Bits Torx 10mm			
17630 20...60	T20; T25; T30; T40; T45; T50; T55; T60 (30mmL)		
17675 20...60	T20; T25; T30; T40; T45; T50; T55; T60 (75mmL)		
10-Bits multidentado 10mm			
17830 05...12	M5; M6; M8; M10; M12 (30mmL)		
17875 05...12	M5; M6; M8; M10; M12 (75mmL)		
810 37...47	2-Adaptador para bits 3/8"DR.x10mm; 1/2"DR.x10mm		

Jogo combinado Spline com 42 pçs			
4422Q			
Código	Soquete	4/19.5/20.5/0.9'	4875g
Composição: 1/2"DR.			
17-Soquete Spline			
54Q 10...32	10; 11; 12; 13; 14; 15; 16; 17; 18; 19; 20; 21; 22; 24; 27; 30; 32 mm		
80242	1-Catraca		
80541	1-Junta universal		
80634	1-Adaptador para extensão		
8044 125...250	2-Extensões 125-5"; 250-10"		
81047	1-Adaptador para bits		
17830 05...12	5-Bits multidentado M5; M6; M8; M10; M12		
17430 05...12	6-Bits hexagonal H5; H6; H7; H8; H10; H12		
17630 20...55	8-Bits Torx T20; T25; T27; T30; T40; T45; T50; T55		



Jogo combinado com 65 pçs			
4652			
Código	2/28.5/29.5/0.77'	14.2kg	
Composição: 1/4" & 1/2" & 3/4" DR.			
Parte 1/4":			
12-Soquete sextavado curto			
525 04...12	4; 5.5; 6; 7; 8; 9; 10; 11; 12;		
525 3.16...3.8	3/16"; 1/4"; 3/8"		
80222	1-Catraca		
8012140	1-Cabo articulado 1/4"		
8032115	1-Cabo de força "T" 1/4"		
8143	1-Cabo de apoio		
8042 050...150	2-Extensão 50; 150 mm		
80521	1-Junta universal		
8032115A	1-Barra auxiliar 115 mmL		
Parte 1/2":			
26-Soquete sextavado curto			
545 08...32	8; 9; 10; 11; 12; 13; 14; 15; 16; 17; 19; 20; 21; 22; 23; 24; 26; 27; 29; 30; 32		
545 3.8...1	3/8"; 1/2"; 9/16"; 11/16"; 1"		
80242	1-Catraca		
8014380	1-Cabo articulado 15"		
8034250	1-Cabo de força "T"		
8044 075...250	3-Extensão 75; 125; 250 mm		
80541	1-Junta universal		
8034150A	1-Barra auxiliar 150 mmL		
Parte 3/4":			
9-Soquete estriado curto			
569 26...41	26; 27; 29; 30; 32; 35; 36; 38; 41 mm		
8026500	1-Catraca 500 mmL		
8046200	1-Extensão 200 mm		



Jogo combinado 14" e 1/2" com 77 pçs			
4772			
Código	3/17.0/18.0/1'	5666g	
Composição: 1/4" & 1/2" DR.			
Parte 1/4":			
9-Soquete sextavado			
525 04...12	4; 5; 6; 7; 8; 9; 10; 11; 12 mm		
80222	1-Catraca		
81022	1-Adaptador para bits 1/4"(F)x1/4"		
80521	1-Junta universal		
8042100	1-Extensão 4"		
8032115	1-Cabo de força "T" 115mmL		
12630 08...30	6-Bits Torx T8; T10; T15; T20; T25; T30		
12430 02...06	5-Bits hexagonal 2; 3; 4; 5; 6 mm		
12330 03...065	4-Bits fenda 3; 4; 5.5; 6.5 mm		
12130 0...3	4-Bits Phillips PH.0; PH.1; PH.2; PH.3		
12230 1...3	3-Bits Pozidriv PZ.1; PZ.2; PZ.3		
8092230	1-Adaptador para bits 1/4"Hex-1/4" Sq.		
Parte 1/2":			
13-Soquete sextavado			
545 10...32	10; 11; 12; 13; 14; 15; 17; 19; 22; 24; 27; 30; 32 mm		
80243	1-Catraca		
8044 125...250	2-Extensão 5"; 10"		
80541	1-Junta universal		
807420.6	1-Soquete de vela com 20.6 mm		
752 0809...1415	4-Chave articulada 8x9; 10x11; 12x13; 14x15 mm		
764 025...10	7-Chave hexagonal "L" 2.5; 3; 4; 5; 6; 8; 10 mm		
755 07...19	11-Chave combinada 7; 8; 9; 10; 11; 12; 13; 14; 15; 17; 19 mm		



Jogo combinado com 94 pçs

4941	Soquete	3/21.0/22.0/1'	7000g
Código	Soquete	3/21.0/22.0/1'	7000g
Composição: 1/4" & 1/2"DR.			
Parte 1/4":			
527 04...14	13-Soquete Surface	4; 4.5; 5; 5.5; 6; 7; 8; 9; 10; 11; 12; 13; 14 mm	
52750 06...13	8-Soquete Surface longo	6; 7; 8; 9; 10; 11; 12; 13; (50mmL)	
18-Chave soquete (32mmL)			
32432 03...06	Hexagonal 3; 4; 5; 6 mm		
32632 08...30	Torx T8; T10; T15; T20; T25; T27; T30		
32332 04...065	Fenda 4; 5.5; 6.5 mm		
32132 1...2	Phillips PH.1; PH.2		
32232 1...2	Pozidriv PZ.1; PZ.2		
80222	1-Catraca		
8042 050...100	2-Extensão 2"; 4"		
8032115	1-Cabo de força "T" 1/2"		
80521	1-Junta universal		
8143	1-Chave de apoio 6"		
764-3	3-Chave hexagonal 1.5; 2; 2.5 mm		
Parte 1/2":			
547 10...32	17-Soquete Surface	10; 11; 12; 13; 14; 15; 16; 17; 18; 19; 20; 21; 22; 24; 27; 30; 32 mm	
54777 14...22	5-Soquete Surface longo	14; 15; 17; 19; 22; (77mmL)	
16-Bits 5/16" (30mmL)			
15430 07...14	Hexagonal 7; 8; 10; 12; 14 mm		
15630 40...55	Torx T40; T45; T50; T55		

Jogo combinado com 94 pçs

4941Q	Soquete	3/21.0/22.0/1'	7000g
Código	Soquete	3/21.0/22.0/1'	7000g
Composição: 1/4" & 1/2"DR.			
Parte 1/4":			
52Q 04...14	13-Soquete Spline	4; 4.5; 5; 5.5; 6; 7; 8; 9; 10; 11; 12; 13; 14 mm	
52Q50 06...13	8-Soquete Spline longo	6; 7; 8; 9; 10; 11; 12; 13; (50mmL)	
18-Chave soquete (32mmL)			
32432 03...06	Hexagonal 3; 4; 5; 6 mm		
32632 08...30	Torx T8; T10; T15; T20; T25; T27; T30		
32332 04...065	Fenda 4; 5.5; 6.5 mm		
32132 1...2	Phillips PH.1; PH.2		
32232 1...2	Pozidriv PZ.1; PZ.2		
80222	1-Catraca		
8042 050...100	2-Extensão 2"; 4"		
8032115	1-Cabo de força "T" 1/2"		
80521	1-Junta universal		
8143	1-Chave de apoio 6"		
764-3	3-Chave hexagonal 1.5; 2; 2.5 mm		
Parte 1/2":			
54Q 10...32	17-Soquete Spline	10; 11; 12; 13; 14; 15; 16; 17; 18; 19; 20; 21; 22; 24; 27; 30; 32 mm	
54Q77 14...22	5-Soquete Spline longo	14; 15; 17; 19; 22; (77mmL)	
16-Bits 5/16" (30mmL)			
15430 07...14	Hexagonal 7; 8; 10; 12; 14 mm		
15630 40...55	Torx T40; T45; T50; T55		

Jogo combinado com 142 pçs

41421	Soquete	2/26.0/27.0/1.54'	13kg		
Código	Soquete	2/26.0/27.0/1.54'	13kg		
Composição: 1/4" & 3/8" & 1/2"DR.					
Parte 1/4":					
26-Bits 1/4" (30mmL)					
12130 0...3	Phillips PH.0; PH.1; PH.2; PH.3			545 08...32	19-Soquete sextavado curto
12230 0...3	Pozidriv PZ.0; PZ.1; PZ.2; PZ.3				8; 10; 12; 13; 14; 15; 16; 17; 18; 19; 20; 21; 22; 23; 24; 25; 27; 30; 32 mm
12330 04...07	Fenda 4; 5.5; 7 mm			546 10...20	5-Soquete Torx
12430 02...10	Hexagonal 2; 3; 4; 5; 6; 7; 8; 10 mm				E10; E12; E14; E16; E20 mm
12730 10...40	Torx com quia T-10H; T15H; T-20H; T-25H; T-27H; T-30H; T-40H			8014430	1-Cabo articulado (430mmL)
525 04...10	9-Soquete sextavado curto			80243	1-Catraca
526 04...08	4; 4.5; 5; 5.5; 6; 7; 8; 9; 10 mm			8044 075...250	2-Extensão 3" ; 10"
80222	5-Soquete Torx curto			80541	1-Junta universal
8042 050...150	E4; E5; E6; E7; E8 mm			80634	1-Adaptador para extensão
80521	1-Catraca				3/8"(F) x 1/2"(M)
80632	3-Extensão 2"; 4"; 6"			8074 16...20.6	2-Soquete de vela 16 ; 20.6 mm
81022	1-Junta universal			8154260	1-Cabo de força em L
8111	1-Adaptador para extensão				Outros:
8143	3/8"(F) x 1/4"(M)			755 06...24	17-Chave combinada
539 06...22	1-Adaptador para bits				6; 7; 8; 9; 10; 11; 12; 13; 14; 15; 16; 17; 18; 19; 21; 22; 24 mm
802318	1-Extensão flexível			751 0810...1719	5-Chave estrela aberta
8043 075...150	1-Chave de apoio 6"				8x10; 10x12; 11x13; 12x14; 17x19 mm
80531	Parte 3/8":			764 025...14	10-Chave L hexagonal
15-Soquete estriado curto					
	6; 7; 8; 9; 10; 11; 12; 13; 14; 15; 17; 18; 19; 21; 22 mm				2.5; 3; 4; 5; 6; 7; 8; 10; 12; 14 mm
	1-Catraca articulada			616300	1-Martelo para montador 300gw
	2-Extensão 3"; 6"			611B175	1-Alicate universal 7"
	1-Junta universal			614250	1-Alicate de pressão 10"
				7111BS	1-Chave phillips tipo toco PH.1
				7112B	1-Chave phillips PH.2
				7112M	Chave philips reforçada PH.2
				713055BS	1-Chave de fenda tipo toco
					5.5mm x 25mmL
				713065B	1-Chave de fenda
					6.5mm x 150mmL
				713065M	1-Chave de fenda reforçada
					6.5mm x 150mmL



Jogo de soquetes e chaves Torx com 73 pçs

4731			
Código	Bits	3/13.5/14.5/1"	4500g
766 08...70	Composição: 1/4" & 1/2"DR. 13-Chave "L" Torx T8; T10; T15; T20; T25; T27; T30; T40; T45; T50; T55; T60; T70		
756 0608...2024	4-Chave plana tipo Torx E6xE8; E10xE12; E14xE18; E20xE24		
546 12...24	7-Soquete Torx 1/2" E12; E14; E16; E18; E20; E22; E24		
526 04...11	7-Soquete Torx 1/4" E4; E5; E6; E7; E8; E10; E11		
346055 30...60	6-Chave soquete Torx 1/2" (55mmL) T30; T40; T45; T50; T55; T60		
32632 08...27	6-Chave soquete Torx 1/4" (32mmL) T8; T10; T15; T20; T25; T27		
17730 10...55	10-Bits Torx 10mm com guia T-10H; T-15H; T-20H; T-25H; T-27H; T-30H; T-40H; T-45H; T-50H; T-55H (30mmL)		
17675 10...55	10-Bits Torx 10mm T10; T15; T20; T25; T27; T30; T40; T45; T50; T55 (75mmL)		
81047	1-Adaptador para bits 1/2"DR.x10mm		
717 06B...40B	9-Chave reta tipo Torx com guia e cabo T6; T8; T10; T15; T20; T25; T27; T30; T40		

Jogo de soquete estriado 3/4" com 14 pçs (MM)

6141B			
Código	Soquete	2/24.0/25.0/1.4'	12kg
569 22...50	Composição: 3/4"DR. 10- Soquete estriado curto 22; 24; 27; 30; 32; 36; 38; 41; 46; 50 mm		
8026500	1- Catraca 500mmL		
8036450	1- Cabo de força "T" 450mmL		
8046 100...200	2- Extensão 100; 200mmL		

Jogo de soquete sextavado 3/4" com 14 pçs (MM)

6141B-5			
Código	Soquete	2/24.0/25.0/1.4'	12kg
569 22...50	Composição: 3/4"DR. 10- Soquete sextavado curto 22; 24; 27; 30; 32; 36; 38; 41; 46; 50 mm		
8026500	1- Catraca 500mmL		
8036450	1- Cabo de força "T" 450mmL		
8046 100...200	2- Extensão 100; 200mmL		



Jogo de chave Torx com 8 pçs

2086B			
Código	Ponta	10/6.0/7.0/1.1'	600g
716 08B...40B	Conteúdo: 8-Chave Torx T8; T10; T15; T20; T25; T27; T30; T40		

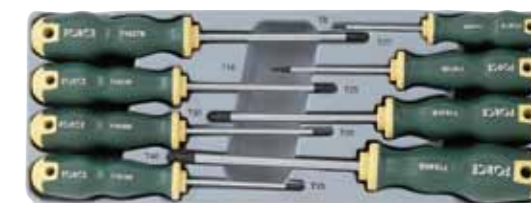

Jogo de chave Torx cabo T com 9 pçs

2096			
Código	Torx	6/10.5/11.5/2.4'	530g
776 04...16	Composição: 9-chave Torx cabo T E4; E5; E6; E7; E8; E10; E12; E14; E16(300mmL)		



Jogo de chave Torx com 7 pçs

5071			
Código	Torx	80/11.0/12.0/0.8'	138g
766 10...40	Conteúdo: 7-Chave Torx T10; T15; T20; T25; T27; T30; T40		



Jogo de chave Torx tipo canivete com 8 pçs

5083F			
Código	Torx	40/13.5/14.5/1.2'	338g
5083F	Composição: 8-Chave Torx (tipo canivete) T9; T10; T15; T20; T25; T27; T30; T40		



Jogo de chave Torx longa com 9 pçs

5098L			
Código	Torx	50/16.5/17.5/1.8'	870g
766 10L...50L	Composição: 9-Chave Torx longa em "L" T10; T15; T20; T25; T27; T30; T40; T45; T50		



Jogo de chave Torx longa com 15 pçs

5151L			
Código	Torx	20/17.5/18.5/1.3'	870g
766 06L...60L	Composição: 15-Chave Torx longa T6; T7; T8; T9; T10; T15; T20; T25; T27; T30; T40; T45; T50; T55; T60		

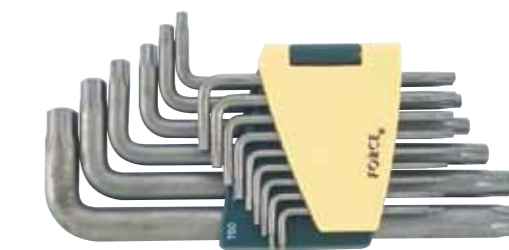



Jogo de chave Torx 5 pontas com guia com 9 pçs

50913			
Código	Torx	80/20.0/21.0/1.7'	250g
76F 10...50	Composição: 9-Chave Torx 5 pontas com guia em "L" TS10; TS15; TS20; TS25; TS27; TS30; TS40; TS45; TS50		



Jogo de chave "L" hexagonal abaulada com 7 pçs(MM)

5072LB			
Código	Tipo	Tipo	50/17.6/18.6/1'
765 025L...10L	Composição: 7-Chave "L" hexagonal longa 2.5; 3; 4; 5; 6; 8; 10 mm		



Jogo de chave "L" hexagonal longa com 11 pçs

5116L			
Código	Tipo	30/12.0/13.0/1.58'	400g
764 015L...12L	Composição: 11-Chave "L" hexagonal longa 1.5; 2; 2.5; 3; 4; 5; 6; 7; 8; 10; 12 mm		



Jogo de chave estriada articulada com 7 pçs

5074			
Código	Estriado	6/13.0/14.0/0.9'	2165g
752 0607...1819	Composição: 7-Chave estriada articulada 6x7; 8x9; 10x11; 12x13; 14x15; 16x17; 18x19 mm		



Jogo de chave Torx articulada com 7 pçs

5075			
Código	Torx	6/13.0/14.0/0.9'	2165g
756 0405F...2224F	Composição: 7-Chave Torx articulada E4xE5; E6xE7; E8xE10; E11xE12; E14xE16; E18xE20; E22xE24		

Jogo de chave combianda curta com 12 pçs

51214P		
Código	20/17.7/18.7/1.3'	885g
755S 08...19	Composição: 12-Chave combinada curta 8; 9; 10; 11; 12; 13; 14; 15; 16; 17; 18; 19 mm	



Jogo de chave combinada com 17 pçs

5175		
Código	10/14.0/15.0/1.3'	1400g
755 06...22	Conteúdo: 12-Chave combinada 6; 7; 8; 9; 10; 11; 12; 13; 14; 15; 16; 17; 18; 19; 20; 21; 22 mm	



Jogo de chave combinada 75° com 17 pçs

5175A		
Código	10/14.0/15.0/1.3'	1400g
755 06A...22A	Conteúdo: 12-Chave combinada 75° 6; 7; 8; 9; 10; 11; 12; 13; 14; 15; 16; 17; 18; 19; 20; 21; 22 mm	



Jogo de chave combinada com 26 pçs

5261P		
Código	3/15.6/16.6/1'	8200g
755 06...32	Composição: 26-Chave combinada 6; 7; 8; 9; 10; 11; 12; 13; 14; 15; 16; 17; 18; 19; 20; 21; 22; 23; 24; 25; 26; 27; 28; 29; 30; 32 mm	



Jogo de chave plana tipo Torx

5041			
Código	Torx	60/20.5/21.5/1.7'	342g
756 0608...2024	Composição: 4-Chave plana Torx E6xE8; E10xE12; E14xE18; E20xE24		





Jogo de chave Torx 75° com 6 pçs			
5065			
Código	Soquete	20/13.8/14.8/1.4'	690g
756 0608A... 2024A	Composição: 6-Chave Torx 75° E6xE8; E7xE11; E10xE12; E14xE18; E16xE22; E20xE24		



Jogo de chave combinada com catraca reversível com 12 pçs (MM)			
51211			
Código		6/13.6/14.6/0.9'	2270g
757 08R...19R	Composição: 12-Chave combinada com catraca reversível 8; 9; 10; 11; 12; 13; 14; 15; 16; 17; 18; 19 mm		



Jogo de chave combinada articulada com catraca com 12 pçs (MM)			
K51210F			
Código		6/14.4/15.4/1.5'	2376g
757 08F...19F	Composição: 12-Chave combinada articulada com catraca 8; 9; 10; 11; 12; 13; 14; 15; 16; 17; 18; 19 mm		



Jogo de chave estrela reta extra longa com 6 pçs			
50622			
Código	Soquete	12/23.8/24.8/1.2'	1980g
760 1012...1719	Composição: 6-Chave estrela extra longa 10x12; 12x14; 13x15; 14x17; 16x18; 17x19 mm		



Jogo de chave estrela reta extra longa com catraca com 6 pçs			
50623			
Código	Soquete	12/20.9/21.9/1.2'	1740g
827 1012...1719	Composição: 6-Chave estrela reta extra longa com catraca 10x12; 12x14; 13x15; 14x17; 16x18; 17x19 mm		

Jogo de chave combinada com catraca com adaptador para soquete - 10 pçs

K51024R			
Código		12/13.3/14.3/1.4'	1110g
757 08R...19R	Composição: 6-Chave combinada com catraca 8; 10; 12; 13; 17; 19 mm		
831 210...419	3-Adaptador para soquete 1/4"DR.(10mm); 3/8"DR.(13mm); 1/2"DR.(19mm)		
831H210	1-Adpatador para bits 1/4"(10mm)		



Jogo de chave combinada com catraca com adaptador para soquete - 16 pçs

5164R			
Código		6/10.7/11.7/0.9'	1780g
757 08R...19R	Composição: 12-Chave combinada com catraca 8; 9; 10; 11; 12; 13; 14; 15; 16; 17; 18; 19 mm		
831 210...419	3-Adaptador para soquete 1/4"DR.(10mm); 3/8"DR.(13mm); 1/2"DR.(19mm)		
831H210	1-Adaptador para bits 1/4"(10mm)		



Jogo de chave estrela aberta intercambiável 3/8" com 11 pçs (MM)

51110			
Código		30/22.0/23.0/1.3'	730g
751 310...319	Composição:3/8"DR. 10-Chave estrela aberta 10; 11; 12; 13; 14; 15; 16; 17; 18; 19mm		
808306	1-Extensão com trava 6"		



Jogo de chave estrela aberta intercambiável com 17 pçs (MM)

5172			
Código		6/12.9/13.9/0.9'	2150g
7513 10...22	Composição: 12-Chave estrela aberta 3/8"DR. 10; 11; 12; 13; 14; 15; 16; 17; 18; 19; 21; 22 mm		
7514 23...26	3-Chave estrela aberta 1/2"DR. 23; 24; 26 mm		
808306	2-Extensão com trava 3/8"DR.(150mmL)		
808405	1/2"DR.(125mmL)		





Jogo de chave estrela 15° com 8 pçs

50821A		
Código	10/8/9/1.1'	800g
760	Composição: 8-Chave estrela 15° 6x7; 8x9; 10x11; 12x13; 14x15; 16x17; 18x19; 20x22 mm	



Jogo de chave meia lua com 9 pçs

50911		
Código	Estriado 6/8.3/9.8/1.3'	1390g
761 0810...1922	Composição: 9-Chave meia lua 8x10; 10x12; 11x13; 12x14; 13x15; 14x17; 16x18; 17x19; 19x22 mm	



Jogo de chave em "S" com 6 pçs

50634		
Código	10/11.0/12.0/1'	1100g
761 1012A...2224A	Composição: 6-Chave em "S" 10x12; 11x13; 14x15; 16x18; 17x19; 22x24	

Chave estrela em "S"

761...A				
Código	Medida	mm	g	pc/cx
7611012A	10x12	142	56	10
7611113A	11x13	142	56	10
7611415A	14x15	188	100	10
7611618A	16x18	225	164	10
7611719A	17x19	237	198	5
7612224A	22x24	270	296	5

Chave cruz para roda

681B400		
Código	12/16.8/17.3/0.9'	1600g
681B400	17; 19; 21; 22 mm com adaptador de 1/2" (400mmL)	

Jogo de chave biela com 8 pçs

50829



Código	10/8/9/1.1'	800g
753 08R...19R	Composição: 8-Chave biela 8; 10; 11; 12; 13; 15; 17; 19	



Chave tipo biela

753..R					
Código	Medida	curto	longo	g	pc/cx
75308R	8	105	255	200	10
75309R	9	105	260	200	10
75310R	10	105	260	335	10
75311R	11	105	260	350	10
75312R	12	105	260	360	10
75313R	13	105	260	370	10
75314R	14	105	260	380	10
75315R	15	105	260	450	10
75316R	16	105	260	480	10
75317R	17	105	260	590	10
75318R	18	105	260	620	10
75319R	19	105	260	720	10



Chave tipo biela com passante

753					
Código	Medida	curto	longo	g	pc/cx
75306	6	20	102	32	10
75307	7	21	106	41	10
75308	8	28	114	56	10
75309	9	29	122	68	10
75310	10	33	129	88	10
75311	11	36	136	120	10
75312	12	40	144	150	10
75313	13	42	152	192	10
75314	14	45	160	204	5
75315	15	47	169	232	5
75316	16	51	178	292	5
75317	17	53	187	316	5
75318	18	54	195	328	5
75319	19	55	204	434	5
75328	28	82	290	1202	5
75330	30	88	310	1454	5
75332	32	98	330	1692	5



Chave Torx com cabo antiderrapante

716..B					
Código	Medida	blade	over	g	pc/cx
71605B	T5	60	145	31	10
71606B	T6	60	145	31	10
71607B	T7	60	145	31	10
71608B	T8	60	145	31	10
71609B	T9	60	145	54	10
71610B	T10	80	185	56	10
71615B	T15	80	185	56	10
71620B	T20	100	205	58	10
71625B	T25	100	205	68	10
71627B	T27	115	230	98	10
71630B	T30	115	230	98	10
71640B	T40	130	245	118	10
71645B	T45	130	255	160	10

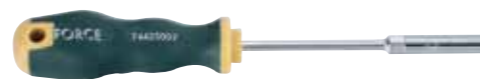

Chave soquete com cabo antiderrapante (tipo canhão)

744					
Código	Medida	blade	over	g	pc/cx
74425004	4	135	250	126	10
744250045	4.5	135	250	126	10
74425005	5	135	250	131	10
744250055	5.5	135	250	136	10
74425006	6	135	250	141	10
74425007	7	135	250	144	10
74425008	8	135	250	147	10
74425009	9	135	250	153	10
74425010	10	135	250	188	10
74425011	11	135	250	194	10
74425012	12	135	250	194	10
74425013	13	135	250	207	10
74425014	14	135	250	234	10



Chave estrela aberta

751					
Código	Medida	mm	g	pc/cx	
7510810	8x10	145	48	10	
7510911	9x11	152	55	10	
7511011	10x11	152	55	10	
7511113	11x13	165	70	10	
7511011S	3/8"x7/16"	152	55	10	
7511214S	1/2"x9/16"	178	95	10	



Chave soquete estriada articulada

752				
Código	Medida	mm	g	pc/cx
7520607	6x7	198	84	10
7520809	8x9	198	90	10
7520810	8x10	201	104	10
7521011	10x11	213	108	10
7521012	10x12	213	110	10
7521213	12x13	227	162	10
7521214	12x14	231	200	10
7521415	14x15	243	230	5
7521617	16x17	253	296	5
7521719	17x19	274	320	5
7521819	18x19	277	388	5
7521922	19x22	290	490	5
7522022	20x22	292	528	5
7522123	21x23	292	548	5
7523032	30x32	360	1080	5



Chave combinada

755				
Código	Medida	mm	g	pc/cx
75506	6	106	19	10
75507	7	116	22	10
75508	8	126	26	10
75509	9	136	34	10
75510	10	146	43	10
75511	11	156	49	10
75512	12	166	63	10
75513	13	176	72	10
75514	14	186	88	10
75515	15	196	101	10
75516	16	206	108	10
75517	17	216	128	10
75518	18	226	145	10
75519	19	236	167	5
75520	20	246	191	5
75521	21	256	224	5
75522	22	266	226	5
75523	23	276	261	5
75524	24	286	281	5
75525	25	296	310	5
75526	26	306	332	5
75527	27	316	363	5
75528	28	326	402	5
75529	29	336	450	5
75530	30	346	512	5
75532	32	366	522	5



Chave combinada 75°

755..A				
Código	Medida	mm	g	pc/cx
75506A	6	130	22	10
75507A	7	130	25	10
75508A	8	140	30	10
75509A	9	150	40	10
75510A	10	160	50	10
75511A	11	170	60	10
75512A	12	180	70	10
75513A	13	190	85	10
75514A	14	200	95	10
75515A	15	210	105	10
75516A	16	220	120	10
75517A	17	230	140	10
75518A	18	240	160	10
75519A	19	250	170	5
75520A	20	260	190	5
75521A	21	270	210	5
75522A	22	280	220	5
75523A	23	290	240	5
75524A	24	300	300	5
75525A	25	310	310	5
75526A	26	315	328	5
75527A	27	325	360	5
75528A	28	335	395	5
75530A	30	355	475	5
75532A	32	375	545	5



Chave plana tipo Torx

756				
Código	Medida	mm	g	pc/cx
7560608	E6xE8	112	14	10
7560711	E7xE11	125	30	10
7561012	E10xE12	140	30	10
7561418	E14xE18	180	70	10
7561622	E16xE22	200	124	10
7562024	E20xE24	224	144	10



Chave Torx 75°

756..A				
Código	Medida	mm	g	pc/cx
7560608A	E6xE8	145	34	10
7560711A	E7xE11	155	42	10
7561012A	E10xE12	175	51	10
7561418A	E14xE18	215	112	10
7561622A	E16xE22	235	192	5
7562024A	E20xE24	265	224	5



Chave estrela 15°

760..A		<i>l</i>		
Código	Medida	mm	g	pc/cx
7600607A	6x7	120	22	10
7600809A	8x9	136	32	10
7601011A	10x11	155	47	10
7601213A	12x13	163	64	10
7601415A	14x15	177	91	10
7601617A	16x17	210	118	10
7601819A	18x19	225	144	10
7602022A	20x22	240	190	10



Chave combinada articulada com catraca

757..F		<i>l</i>		
Código	Medida	mm	g	pc/cx
75708F	8	130	50	10
75709F	9	155	73	10
75710F	10	155	73	10
75711F	11	173	99	10
75712F	12	173	99	10
75713F	13	185	116	10
75714F	14	191	133	10
75715F	15	215	198	10
75716F	16	215	198	10
75717F	17	230	223	10
75718F	18	248	276	10
75719F	19	248	276	10



Chave "L" Torx longa

766..L		<i>l</i>	<i>l</i>		
Código	Tipo	curto	longo	g	pc/pte
76610L	T10	19	86	6	10
76615L	T15	21	90	8	10
76620L	T20	23	95	11	10
76625L	T25	25	98	18	10
76627L	T27	26	105	19	10
76630L	T30	29	115	30	10
76640L	T40	33	122	45	10
76645L	T45	36	138	62	10
76650L	T50	40	155	90	10
76655L	T55	45	172	164	10
76660L	T60	52	200	267	5



Chave "L" hexagonal longa

764		<i>l</i>	<i>l</i>		
Código	Tipo	curto	longo	g	pc/pte
764015	1.5	14	90	4	10
76402	2	16	100	6	10
764025	2.5	18	112	6	10
76403	3	20	126	10	10
76404	4	25	140	18	10
76405	5	28	160	33	10
76406	6	32	180	53	10
76407	7	34	190	75	10
76408	8	36	200	103	10
76409	9	38	210	137	10
76410	10	40	224	180	10
76411	11	42	240	230	10
76412	12	45	250	300	5
76413	13	50	260	356	5
76414	14	56	280	452	5
76416	16	60	300	627	5
76417	17	63	320	784	5
76419	19	70	360	1095	5



Chave "L" hexagonal extra longa

764..XL		<i>l</i>	<i>l</i>		
Código	Tipo	curto	longo	g	pc/pte
764015XL	1.5	14	90	4	10
76402XL	2	16	100	6	10
764025XL	2.5	18	112	6	10
76403XL	3	20	126	10	10
76404XL	4	25	140	18	10
76405XL	5	28	160	33	10
76406XL	6	32	180	53	10
76407XL	7	34	190	75	10
76408XL	8	36	200	103	10
76409XL	9	38	210	137	10
76410XL	10	40	224	180	10
76411XL	11	42	240	230	10
76412XL	12	45	250	300	5
76413XL	13	50	260	356	5
76414XL	14	56	280	452	5
76416XL	16	60	300	627	5
76417XL	17	63	320	784	5
76419XL	19	70	360	1095	5



Catraca reversível - 1/2"

80244	<i>l</i>		
Código	mm	g	pc/box
80244	245	644	1



Catraca reversível 36 dentes - 1/2"

80245	<i>l</i>		
Código	mm	g	pc/box
80245	251	599.5	1



Catraca reversível articulada

802418	<i>l</i>		
Part no.	mm	g	pc/box
802418	290	798	1



Catraca reversível articulada 72 dentes - 1/4"

802223	<i>l</i>		
Código	mm	g	pc/box
802223	150	126	1

Catraca reversível articulada 72 dentes - 1/2"

802423	<i>l</i>		
Código	mm	g	pc/box
802423	303	656	1



Catraca reversível - 1/4"

80222	<i>l</i>		
Código	mm	g	pc/cx
80222	155	168	10

Catraca reversível - 1/2"

80242	<i>l</i>		
Código	mm	g	pc/cx
80242	270	754	1



Catraca reversível 72 dentes - 1/4"

80229	<i>l</i>		
Código	mm	g	pc/cx
80229	145	116	10

Catraca reversível 72 dentes - 1/2"

80249	<i>l</i>		
Código	mm	g	pc/cx
80249	245	520	1



Catraca reversível - 3/4"

8026	<i>l</i>		
Código	mm	g	pc/box
8026500	500	1970	10



1/4"



Cabo de apoio flexível

8113		<i>l</i>		
Código	Medida	mm	g	pc/box
8113	1/4"DR.	275-11"	151	10

Cabo de força "T" - 1/4"

8032	<i>l</i>		
Código	mm	g	pc/cx
8032115	115	42	10

Cabo de força "T" - 1/2"

8034	<i>l</i>		
Código	mm	g	pc/cx
8034250	250-10"	379	10
8034300	300-12"	445	10

Cabo de força "T" - 3/4"

8036	<i>l</i>		
Código	mm	g	pc/cx
8036450	450-18"	1380	10
8036500	500-20"	1500	10

Cabo articulado de 1/2"

8014	<i>l</i>		
Código	mm	g	pc/cx
8014250	250-10"	516	5
8014380	380-15"	772	5
8014430	430-17"	886	5

Cabo articulado de 1/2"

8014600	<i>l</i>		
Código	mm	g	pc/cx
8014600	600-24"	1400	12

Cabo articulado de 3/4"

80161000	<i>l</i>		
Código	mm	g	pc/cx
80161000	1000-40"	3670	5

Extensão abaulada - 1/4"

8042..W	<i>l</i>		
Código	mm	g	pc/cx
8042050W	50-2"	24	20
8042075W	75-3"	36	10
8042100W	100-4"	46	10
8042150W	150-6"	66	10
8042225W	225-9"	102	10
8042250W	250-10"	110	10

1/2"



Extensão abaulada - 1/2"

8044..W	<i>l</i>		
Código	mm	g	pc/cx
8044050W	50-2"	92	10
8044125W	125-5"	185	10
8044200W	200-8"	280	10
8044250W	250-10"	346	5

1/2"



Junta Universal - 1/2"

80541	<i>l</i>		
Código	mm	g	pc/cx
80541	70	149	10

1/2"

3/4"



Impacto



Junta universal de impacto - 1/2"

80541MPB	<i>l</i>		
Código	mm	g	pc/cx
80541MPB	75	139	10

Junta universal de impacto - 3/4"

80561MPB	<i>l</i>		
Código	mm	g	pc/box
80561MPB	110	624	1



Extensão extra longa - 1/2"

8044	<i>l</i>		
Código	mm	g	pc/box
8044450	450-18"	766	30
8044600	600-24"	1008	15
8044750	750-30"	1260	20

Extensão - 3/4"

8046	<i>l</i>		
Código	mm	g	pc/box
8046400	400-16"	1400	15

1/2"



Impacto



Extensão de impacto - 1/2"

8044..MPP	<i>l</i>		
Código	mm	g	pc/box
8044075MPP	75-3"	148	10
8044125MPP	125-5"	230	10
8044250MPP	250-10"	443	5

Impacto

1/2"

3/4"

Impacto



Adaptador de impacto - 1/2"

8094..MPB	<i>l</i>			
Código	Size	mm	g	pc/box
80946MPB	1/2"(F)x3/4"(M)	48	145	10

Adaptador de impacto - 3/4"

8096..MPB	<i>l</i>			
Código	size	mm	g	pc/box
80964MPB	3/4"(F)x1/2"(M)	58	320	2



Soquete de vela estriado magnético - 1/2"

8074..M	●	l	g	pc/cx
Código	Medida	mm	g	pc/cx
807414M	14 mm	70	80	10
807416M	16 mm	70	83	10
807418M	18 mm	70	135	10
807420.6M	20.6 mm	70	153	10



Chave de vela magnética extra longa - 3/8"

8073250..M	●	l	g	pc/cx
Código	soquete	mm	g	pc/cx
807325014M	14mm	250	316	10
807325016M	16mm	250	344	10
807325020.6M	20.6mm	250	440	10

* 807325014M serve para Citroën C5 HPI, Peugeot 406 HPI, Renault Clio 1,2 16V; Twingo 1,2 16V.

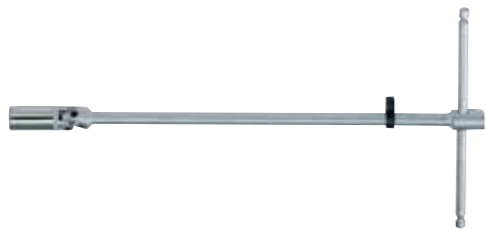

Chave "T" articulada com soquete de vela estriado magnético - 1/2"

8074..UM	●	l	g	pc/cx
Código	Medida	mm	g	pc/cx
807450016UM	16mm	500	554	30
807450020.6UM	20.6mm	500	592	30



Jogo de adaptador com 8pçs

K4087	●	g
Código	ADAPTADOR	24/26.5/27.5/1.5'
809 23...86	Composição: 1/2"DR. 8-Adaptador 1/4"(F)x3/8"(M); 3/8"(F)x1/4"(M); 3/8"(F)x1/2"(M); 1/2"(F)x3/8"(M); 1/2"(F)x3/4"(M); 3/4"(F)x1/2"(M); 3/4"(F)x1"(M); 1"(F)x3/4"(M)	1750g



Adaptador

809	l	g	pc/cx	
Código	Medida	mm	g	
80923	1/4"(F) x 3/8"(M)	26	18	25
80932	3/8"(F) x 1/4"(M)	35	31	10
80934	3/8"(F) x 1/2"(M)	46	47	10
80943	1/2"(F) x 3/8"(M)	46	65	10
80946	1/2"(F) x 3/4"(M)	46	163	10
80964	3/4"(F) x 1/2"(M)	50	308	5
80968	3/4"(F) x 1" (M)	60	407	2
80986	1" (F) x 3/4"(M)	70	964	2



Adaptador para bits

810	l	g	pc/cx	
Código	Medida	mm	g	
81022	1/4"(F) x 1/4"(F)	25	14	10
81042	1/2"(F) x 1/4"(F)	38	53	10
81045	1/2"(F) x 5/16"(F)	38	57	10
81047	1/2"(F) x 10mm(F)	38	57	10
810414	1/2"(F) x 14mm(F)	38	90	10



Martelete de impacto manual - 1/2"

5064	●	g
Código	embalagem	20/19.0/20.0/0.62'
8174	Composição: 1/2" DR. 1- Martelete de impacto 4- Bits 5/16" Phillips PH.2; PH.3 (36mmL) Fenda 9; 11 mm (36mmL)	950g
15136 2...3	Phillips PH.2; PH.3 (36mmL)	
15336 09...11	Fenda 9; 11 mm (36mmL)	
81045A	1- Adaptador para bits 1/2"DR.x5/16"	

Martelete de impacto manual com 17pçs

5171	●	g
Código	embalagem	20/22.0/23.0/0.82'
8174	Composição: 1/2" DR. 1- Martelete de impacto 14- Bits 5/16" Phillips PH.2; PH.3 (36mmL) Pozidriv PZ.2; PZ.3 (36mmL) Fenda 9; 11 mm (36mmL) Torx T25; T30; T40; T45; T50 (35mmL) Hexagonal 6; 8; 10 mm (36mmL)	1100g
15136 2...3	Phillips PH.2; PH.3 (36mmL)	
15236 2...3	Pozidriv PZ.2; PZ.3 (36mmL)	
15336 09...11	Fenda 9; 11 mm (36mmL)	
15635 25...50	Torx T25; T30; T40; T45; T50 (35mmL)	
15436 06...10	Hexagonal 6; 8; 10 mm (36mmL)	
81045A	1- Adaptador de impacto para bits 1/2"DR.x5/16"	
8095330	1- Adaptador para bits 5/16"Hexagonal-3/8"Quadrado	

Alicate de pressão

614B225	●	l	g
Código	embalagem	mm	g
614B225	40/23.0/24.0/1'	225-9"	575

Alicate de pressão para solda

66006	●	l	g
Código	embalagem	mm	g
66006	72/16.6/17.6/0.67"	6"	230

Alicate de pressão para solda em "U"

66201	●	l	g
Código	embalagem	mm	g
66201	40/22.8/23.8/1.4'	9"	570



Alicate de freno			
6958...		<i>l</i>	
Código	L(pol.)	L(mm)	g
6958160	6"	160	220
6958225	9"	225	360



Alicate de bico reto extra longo			
5047P1		<i>l</i>	
Código	Embalagem	mm	g
5047P1	50/16.5/17.5/0.64'	280-11"	330
5047P1L	50/17.5/18.5/0.83'	400-15.7"	480



Alicate para cabo de vela			
5047P4		<i>l</i>	
Código	Embalagem	mm	g
5047P4	50/16.5/17.5/0.64'	280-11"	330

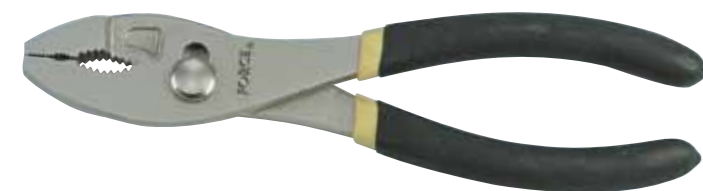

Alicate tipo ford			
673B215		<i>l</i>	
Código	Embalagem	mm	g
673B215	60/16.5/17.5/2'	215-8.5"	275



Jogo de saca pino paralelo com 6 pçs			
50613			
Código	30/16.7/17.7/1.3'	540g	
604 2140...8215	Composição: 6-Saca pino 2mm (140mmL); 3mm (150mmL); 4mm (190mmL); 5mm (200mmL); 6mm (210mmL); 8mm (215mmL)		

Cinta para anéis de pistão			
620	Capacidade	<i>l</i>	
Código	mm	inch	g
6203175	90-175	3"	308
6204175	90-175	4"	350
6206175	90-175	6"	600



Alicate para anéis de pistão				
623		<i>W</i>	<i>l</i>	
Código	Aplicação	mm	mm	g
62301	Automóvel	140	3"	250
62302	Caminhão	190	3"	370
62303	Caminhonete	80-120	2.5"	170

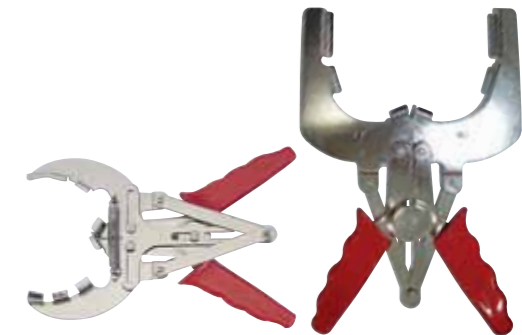

Alicate para abraçadeira elástica		
62518		
Código	72/17.3/18.3/2.2'	240g



Alicate para abraçadeira homocinética		
62520		
Código	48/17.8/18.8/1.5'	354g



Alicate angular para abraçadeira		
62522		
Código	72/15.0/16.0/3.3'	208g



Ventosa dupla de plástico			
63404		Cap	
Part no.	packing	kgs	g
63404	20/19.5/20.5/4'	80	975





Arco para lima

65701		
Código	20/15.7/16.7/2.1'	785g



Lima de funileiro

6571409			
Código	dentes por polegada	inch	g
6571409	9	14"	310



Jogo de lima com cabo com 5pçs

5056		
Código	6/10.2/11.2/0.9'	1690g

- Composição:
- 5056P1 1-8" Lima chata
 - 5056P2 1-8" Lima meia cana
 - 5056P3 1-8" Lima redonda
 - 5056P4 1-8" Lima quadrada
 - 5056P5 1-8" Lima triangular

Calibre de lâmina com 26 pçs

61802			
Código	100/12.0/13.0/1.1'	95mm	120g

Contém 26 lâminas
 0.04mm(.0015");0.05mm(.002");0.06mm(.0025")
 0.08mm(.003");0.10mm(.004");0.13mm(.005")
 0.15mm(.006");0.18mm(.007");0.20mm(.008")
 0.23mm(.009");0.25mm(.010");0.28mm(.011")
 0.30mm(.012");0.33mm(.013");0.35mm(.014")
 0.38mm(.015");0.40mm(.016");0.43mm(.017")
 0.45mm(.018");0.48mm(.019");0.50mm(.020")
 0.53mm(.021");0.55mm(.022");0.58mm(.023")
 0.60mm(.024");0.63mm(.025")



Alicate para abraçadeira elástica - sistema de arrefecimento e ar-condicionado

9G0201			
Código			

Cabo flexível com ímã

61702		
Código	72/11.0/12.0/1.8'	150g

- * Haste flexível com 5.0mm de diâmetro; 400mmL
- * Cabo de PVC
- * Capacidade magnética: 1.5Lbs (0.7Kgw)
- * Comprimento total: 510mm (20")

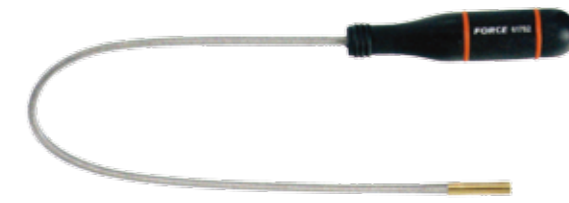

Cabo flexível com ímã

61701		
Código	100/19.0/20.0/1.9'	190g

- * Haste flexível com 8.5mm de diâmetro; 440mmL
- * Cabo de PVC
- * Capacidade magnética: 3.5Lbs (1.6Kgw)
- * Comprimento total: 535mm (21")

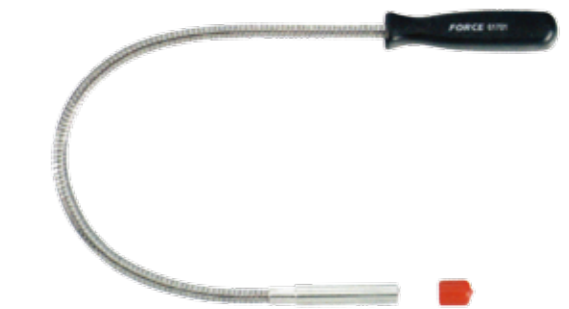

Chave cabo "T" com soquete sextavado articulado

784..U					
Código	Medida	blade	width	g	pc/box
784208U	8	400	165	210	10
784310U	10	450	175	392	10
784313U	13	450	175	425	10
784314U	14	500	180	425	10
784315U	15	500	180	430	10
784317U	17	500	180	430	10
784419U	19	500	220	880	10



Chave L multidentada extra longa M8

76808XL					
Código	Medida	curto	longo	g	pc/cx
76808XL	M8	55	260	55	10



Jogo de soquete de impacto para roda liga leve com 4 pçs

4107			
Código	Soquete	12/15.2/16.2/0.5'	1266g

Composição: 1/2"DR.
 04-Soquete de impacto longo
 17; 19; 21; 22mm



* Soquetes avulsos disponíveis



Torquímetro

647...W



Código	Capacidade	<i>l</i>	
	Nm	mm	g
6474500W	1/2" DR. 20-200	500	1200



Toquímetro de estalo com catraca reversível

647...W	Capacidade		<i>l</i>	
Código	Nm	embalagem	mm	g
6472195W	1/4"DR. 3-15	20/17.2/18.2/1.63'	195	210

Toquímetro de estalo com catraca reversível

647	Capacidade		<i>l</i>	
Código	Nm	embalagem	mm	g
6473295	3/8"DR. 6-30	20/17.2/18.2/1.63'	295	860
6474535	1/2"DR. 40-210	10/20.3/21.3/1.31'	535	2030

Transferidor de grau

9G1801		
Código	24/12.0/13.0/1.6'	500g

* Encaixe de 1/2"

4-5/16" (65mm a 110mm)

* Braço flexível com ponta tipo clip



Multiplicador de torque

65113L



Composição:

- 65113 2-Multiplicador de torque & barra de apoio de 380mm 3/4"(F)x1"(M) Saída máx 2500 Nm
- 65113L-1 1-Barra de apoio de 90°
- 65113L-2 1-Base de apoio de 90°

3/10.5/11.5/1.2' 3500g



Multiplicador de torque

65101L



Código	Saída Máx	Encaixe	Proporção
	Nm / Ft-lb	Medida	
65101L	1500/1100	1/2" - 3/4"	1:3
	Entrada Máx		
	Nm / Ft-lb	embalagem	g
	500/365	4/14.4/15.4/0.75'	3600



Banco metálico para oficina mecânica

9U0312



• Medida: 40 × 30 × 30 mm

1/7.5/8.5/1.4' 7.5kg





■ JOGO DE SACA FILTRO TIPO COPO

61917



3/21.2/22.2/3.1' 7060g

Especificação	Aplicação
• 66mm/6P	Flat (Punto, 1.2) Renault (Clio 1.2 Express, Kangoo, Twingo) etc...
• 65mm/14P	Champ, Hastings. GM/AC, Wix, Napa, Purolator, Diahatsu, Toyota, Nissan, etc...
• 65-67mm/14P	Serve para filtros feitos no Canadá incluindo PH4386, PH4967, PH6017, PH6018. Daihatsu. etc...
• 68mm/14P	Hastings, Mazda, Ford Escort, Capri, Subaru, Fran PH6607
• 73mm/14P	Toyota / Lexus, etc...MF, Audi, #056-115-561g, GM, Rover, Chrysler. etc...
• 74mm/15P	Fram, AC, Saturnm, etc...
• 74-76mm/15P	VW, Audi, Casite, GM / AC, Hastings,Wix, NAPA Ford. Isuzu Mercedes, Opel, etc...
• 75-77mm/15P	Fiat (z.B. Ducato, Scudo, Ulysee), Renault,(Megane, Laguna, Espace III) etc...
• 76mm/12P	Champion, Champ Lee, Purolator, Mopar, VW, Porsche, Mercedes, Benz, BMW, Audi, (I.B.A3TD) Opel. etc...
• 76mm/14P	Motorcraft only-FL400A, Ford. etc...
• 76mm/30P	Fiat (z.B.Marea), Lancia (z.B.Delta) etc...
• 76mm/8P	Nissan # 15208H8991, Ford, Toyota, Accord, etc...
• 78mm/15P	Hastings, Fram, Purolator, Nissan, Honda, Motorcraft, Mazda, Isuzu, Subaru, Opel, Toyota, etc...
• 80mm/15P	Mazda, Subaru, Toyota, Honda, Acura, Nissan, NAPA, etc...
• 80-82mm/15P	Volvo (C40, S60, S70, S80) etc...
• 86mm/16P	VW, Golf (MKIII, Tdi, Passat Tdi), Audi A6 Tdi, Renault (Clio, Rapid 1.9D Laguna, Safrane, Espace 2.1D), Cifroen, Peugeot, Renault, etc...
• 86mm/18P	Honda Accord, Mitsubishi, Mopar, Isuzu etc...
• 90mm/15P	Fiat, Cinquedento, Coupe, Croma, Fiat, Panda, Regata, Ritmo Fiat, Seicento, Tempra, Tipo,
• 92mm/10P	Lancia (Beta, Dedra, Kappa, Monte, Carlo, Prisma, Thema, Trevi) etc... Casite, Champ, Champion, GM, Fram, Hastings, Opel, Mazda, Volvo, Mitsubishi, Purolator, Wix, Nissan, VW, Porsche, Renault Ford, Honda, Audi, etc...
• 93mm/15P	Motorcraft only-FL1A, FLA1B, FL300, FL820, Ford, etc...
• 93mm/36P	VW-Audi. (Tdi 2.4,2.6,2.8L) etc...
• 93mm/45P	Toyota # 15600-41010, Alfa, GM, Ford, ALFA, Chrysler, etc...
• 95mm/15P	Audi (A4, A6. Tdi), VW(Passat 97 Tdi) Renault(Laguna 2.2d, Safrane 2.2D.) Espace 2.2D, R19, Rapid, Megane 1.9 / 2.1D.TDi) etc...
• 96mm/18P	Motorcraft, Isuzu, Mitsubishi, etc...
• 100mm/15P	Fiat (Ducato 2.5D. Td) etc...
• 106mm/15P	Volvo (C70, S70, V70. Tdi. TD) (Turbo. Diesel. 850 Tdi. Diesel) etc...
• 108mm/15P	Renault (Espace, Laguna, Master, Safrane, Traffic 2.4, 2.5, 2.8D,TD) etc...
• 108mm/18P	
• 61904A	Saca filtro de 3 garras
•	Adaptador

Saca filtro de óleo com 3 garras

61904		
Código	20/12.0/13.0/0.7'	590g

* Remove filtros de óleo de diâmetro entre 2-1/2" e 4-5/16" (65mm a 110mm)
 * Encaixe de 3/8" e vem com um adaptador para 1/2"



Saca filtro de óleo com 3 garras

61904A		
Código	36/15.0/16.0/1'	415g

* Remove filtros de óleo de diâmetro entre 63 a 102mm
 * Encaixe de 3/8" e vem com um adaptador para 1/2"



Chave para filtro de óleo

61910	Medida	
Código	mm	g
61910	65 - 110	210
61910L	110-155	230

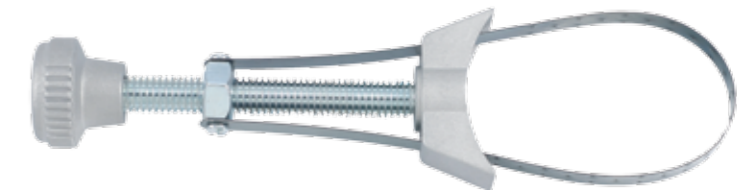

Alicate para filtro de óleo ajustável

639	Filtro			
Código	Medida	embalagem	inch	g
639250	60-90mm	60/21.2/22.2/2"	10"	353
639300	85-115mm	60/22.7/23.7/2"	12"	378



■ Alicates de pressão para filtro de óleo

639230



	Capacidade			
Código	mm	embalagem	mm	g
639230	53-118mm	40/19.5/20.5/1.7'	230	480

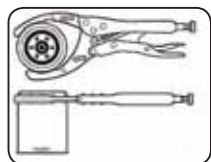



Jogo de saca polia universal



66626



- 1 trilho para 2 garras
- 1 trilho para 3 garras
- 9 garras, comprimento 100 / 200 / 250 mm
- 2 eixos

3/20.5/21.3/1.2' 7200g



Saca polia - 2 garras

Código	Medida	Embalagem	g
6590103	3"	40/17.6/18.6/0.92"	440
6590104	4"	20/15.5/16.5/0.75"	775
6590106	6"	10/16.5/17.5/1.2"	1650
6590108	8"	5/17.5/18.5/1.2"	3500
6590112	12"	3/21.0/22.0/1.6"	7000



Saca polia - 3 garras

Código	Medida	Embalagem	g
6590203	3"	30/16.5/17.5/0.9"	550
6590204	4"	20/17.0/18.0/0.8"	1060
6590206	6"	8/18.0/19.0/1"	2250
6590208	8"	4/18.0/19.0/1.35"	1500
6590212	12"	1/11.0/12.0/1"	11kg

Ferramenta para descolar pivôs e terminais



628



Part no.	Open size	l mm	packing	g
628300	15/16"	300	25/17.0/18.0/0.38'	680
628400	21/32"	400	20/19.0/20.0/0.38'	950



Extrator do terminal de direção

628E...	Medida	Embalagem	g
628E18	18mm	60/19.8/20.8/1.2'	330
628E23	23mm	30/16.4/17.4/1'	545
628E29	29mm	20/18.2/19.2/0.9'	910



Extrator de rolamento

666...	Abertura	Embalagem	g
666050	1-1/4" to 2-1/4" (30-50mm)	20/20.0/21.0/0.5'	1000
666075	2-1/4" to 3-1/2" (50-70mm)	12/18.0/19.0/0.6'	1500
666105	3" to 4-1/2" (75-105mm)	10/20.0/21.0/0.7'	2000
666150	4" to 6" (105-150mm)	4/30.0/31.0/1'	5000



Jogo de extrator de rolamento

66602	Embalagem	g
66602	2/15.0/16.0/1'	7.5kg



Jogo de espátulas com 5 pçs

905M1	Embalagem	g
905M1	48/19.3/20.3/3'	400g



Chave para sonda lambda - 1/2"

44322	Medida	mm	g	pc/cx
44322	22	85	200	10



Jogo de chave para sensores com 7 pçs

907G2	Embalagem	g
907G2	10/32.4/33.4/2'	3240g





■ Chave para sonda lambda extra longa - 1/2"



44315022



- Medidas: 1/2" DR. 22mm x Sextavado x 150L.
- Aplicação: MERCEDES-BENZ C/E, 602, 605, 606 VW/AUDI/SKODA/SEAT, BMW, FORD, OPEL, ROVER, VOLVOL.

48/17.4/18.4/1.3' 362g

■ Jogo de ferramenta para pressionar êmbolo da pinça de freio com 27 pçs



927B2



- Aplicação: GM, MERCEDES, ALFA ROMEO, CITROEN, FIAT, VW, AUDI, FORD, ROVER, LINCOLN, NISSAN, SUBARU, HONDA, BMW, MITSUBISHI, TOYOTA, PEUGEOT, OPEL, RENAULT, JAGUAR, MAZDA, VOLVO, VAUXHALL, SAAB, LANCIA.

5/16.0/17.0/1' 3kg

■ Jogo de ferramenta para reparo de rosca



916G3



10/17.5/18.5/1.6' 1750g

■ Ferramenta para retornar o êmbolo da pinça de freio



62901



20/22.1/23.1/1.3' 1100g



■ Ferramenta para abrir pinça de freio (4 pistões)



62902



12/20.2/20.7/1.9' 1550g

■ Medidor manual de espessura de pastilha de freio



908B2



- Medidas:
Vermelho (Troca imediata): 2mm (0.0787") ; 3mm (0.1181")
Amarelo (Atenção): 4mm (0.1575") ; 5mm (0.1969") ; 6mm (0.2362")
Azul (Bom): 8mm (0.3150") ; 10mm (0.3937") ; 12mm (0.4724")

72/18.0/19.0/1.7' 250g



■ Ferramenta para braço axial



9T0801



- Capacidade: 33-42 mm

36/19.3/20.3/0.9' 536g





Saca prisioneiro

818A



- Encaixe de 1/2"
- Capacidade: 6 - 19mm (1/4" - 3/4")



30/16.9/17.9/0.55' 560g



Jogo de martelo de tacho para funilaria com 7pçs

50713B



Composição:

- 62602 1-Martelo cabeça redonda convexa e pena
- 62603 1-Martelo cabeça plana redonda e quadrada serrilhada
- 62604 1-Martelo cabeça plana redonda e quadrada
- 68301 1-Trilho
- 68302 1-Recurvado
- 68303 1-Tacão
- 68304 1-Cunha

3/22.0/23.0/1.7' 7300g



Extratores de expansão de parafusos e porcas com 12 pçs

912U3



- Remove porcas e parafusos danificados

Composição:

- 4-Extrator de expansão 3/8" DR. 8; 10; 12; 13mm
- 6-Extrator de expansão 1/2" DR. 14; 15; 16; 17; 19; 21mm

20/15.5/16.5/0.9' 775g



Jogo de alicate de pressão axial com 6 pçs

50635



Composição:

- 6-Alicate de pressão axial
- 67901 Garra plana
- 67902 Garra dupla curvada
- 67903 Garra curvada
- 67904 Garra angular
- 67905 Garra reta
- 67906 Garra reta mini

3/13.5/14.5/1.5' 4520g



Jogo de saca prisioneiro com 4 pçs (MM)

5042



Composição:

- 4-Saca prisioneiro 6; 8; 10; 12 mm

20/16.5/17.5/0.82' 825g



Compressor de mola

627280U



- Compressor de mola de alta segurança com 1200kg de capacidade máxima por par e uma barra auxiliar ajustável.
- Capacidade: 23 mm ~ 280 mm
- Comprimento 280 mm

4/17.0/18.0/0.4' 4.2kg





Jogo de ferramenta para tensionar correia dentada

913T1



12/19.6/21/1.4'

1633g

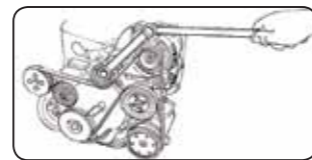

Jogo de alinhador de embreagem com 17 pçs

917T2



12/15.5/16.5/1.4'

1290g



Chave para filtro de óleo

61906



Código	Caixa	l mm	g
61906073	36/12.0/13.0/2.6'	2-3/8" to 2-7/8" (60mm - 73mm)	335
61906085	36/13.4/14.4/2.6'	2-7/8" to 3-3/8" (73mm - 85mm)	372
61906095	36/14.0/15.0/2.6'	3-3/8" to 3-3/4" (85mm - 95mm)	389
61906111	36/14.7/15.7/2.6'	3-3/4" to 4-3/8" (95mm - 111mm)	408



Ferramenta tensionadora para abraçadeira de nylon

54111P1



Código	Caixa	l mm	g
54111P1	60/13/14/3.4'	170	216



Ferramenta para abraçadeira da coifa homocinética com cortador

62521



36/18.3/19.3/1.8'

510g



Ferramenta para abraçadeira da coifa homocinética com cortador

62525



72/20.5/21.5/2.5'

285g

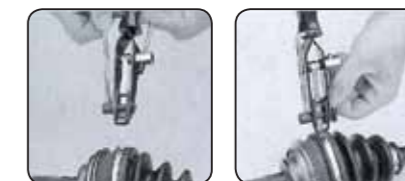

Esmirilhador de válvula manual

902G7



108/16.0/17.0/2.9'

100g



Jogo de ferramentas para remover retentor

903G13

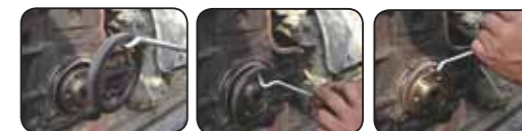

130/6.4/7.4/1.4'

200g





Jogo de flangeador e cortador de tubo

656 / 656M



- 1pç cortador de tubo.
- 1pç 9/16" flangeador.
- 7pçs Adaptador 3/16"; 1/4"; 5/16"; 3/8"; 7/16"; 1/2"; 5/8"

656M muda os itens:

- 7pç Adaptador 4; 6; 8; 10; 12; 14; 16 mm (5/8")

10/16.1/17.1/1.8' Δ 1610g



Cortador de tubo

65601



- Capacidade: 1/8" a 1-1/8" (3-29mm)



60/14.0/15.0/1.9' Δ 233g



Cortador de tubo

65603



- Capacidade: 1/8" a 1-1/8" (3-29mm)

30/16.7/17.7/1.3' Δ 556g

Jogo de alicate para anéis intercambiável com 4 pçs

904U3



- Capacidade: 10 – 50 mm (3/8" – 2")
- Inclui 4 pontas intercambiáveis
- 2 pçs ponta reta
- 1 pç ponta angular de 90°
- 1 pç ponta angular de 45°
- 6 posições para anéis internos e externos



60/9.9/10.9/1.8' Δ 165g



Soquete Torx extra longo para cabeçote

546150...B



Código	Soquete	mm	g	pc/cx
54615012B	E12	150	153	10
54615014B	E14	150	155	10



Jogo de bits Torx com 11 pçs

21113



Código	Bit	100/14.0/15.0/1.5'	140g
12625 07...40	Composição: 1/4" 10-Bits Torx 1/4" (25mmL) T-7; T-8; T-9; T-10; T-15; T20; T25; T-27; T-30; T-40		
81260Q	1-Adaptador magnético para bits 1/4" com sistema engate rápido		



Alavanca

904U6



- 904U606 - 6";
- 904U612 - 12";
- 904U616 - 16";
- 904U620 - 20"

6/10.2/11.2/0.71' Δ 1700g



Chave angular para carburador de moto

910Y1



- Ferramenta de longo alcance especialmente desenvolvida para ajuste de carburador de moto
- Cada giro no cabo corresponde a um giro na chave
- Chaves reta e 90°
- Acompanha um jogo de bits

12/11.0/12.0/2.1' Δ 916g





Ferramenta hexagonal 4 em 1 para eixo de moto



9Y0151



- Encaixa no hexagonal interno do eixo de diversos modelos de motos esportivas e algumas motocross
- Quatros medidas: 17, 19, 22 e 24mm.
- Encaixe de 3/8" para catraca numa das pontas
- Aplicações:
BMW: 1200GS BMW: R1200 RT
Buell: XB9R, XB9S, XB12R, XB12S (2003-2004)
Honda: CBR600RR, CBR1000RR
Kawasaki: ZX6R, ZX6RR, ZX600E/K, ZX7R, ZX9R, Z1000
Suzuki: GSXR 2000-2004, DL 1000 V-Strom (todas), SV1000
Yamaha: R1, R6



100/17.0/18.0/0.6' 170g

Jogo de chaves para alternador com 22 pçs



922G3



- Aplicação: VW, Audi, Seat, Mercedes Benz, Renault, BMW, Ford Renault, Fiat, etc....
- Especificação: A. 17mm HEX Socket , B. 22mm HEX Socket C. 22*28mm HEX Socket , D. 21*28mm HEX Socket E. 19*28mm HEX Socket , F. 35mm Round W/4pin G. 38mm HEX W/3pin , H. Ø 17.6*15mm HEX*33T I. Ø 19.2*15mm HEX*33T , J. Ø 19.3*22mm HEX*33T K. 3/8" Dr.* M10x72mmL W/ Ø14*12mm HEX*31T L. 1/2" Dr. * T50x110mmL W/ Ø19.5*17mm HEXx33T M. 1/2" Dr. * M10x110mmL W/ Ø19.5*17mm HEXx33T N. Bit H10 socket w/10mm hex drive end



4/8.7/9.7/0.9' 2169g

Chave para alternador M10 com 2 pçs

674			
Código	100/21.2/22.2/1.5'	110mm	212g

- * Chave especial multidentada para polia com catraca dos alternadores Valeo e Bosch.
- * Chave soquete multidentada M10

Chave para alternador T50 com 2 pçs

678			
Código	100/21.2/22.2/1.5'	110mm	212g

- * Chave especial multidentada para polia com catraca dos alternadores Valeo e Bosch.
- * Chave soquete Torx T50



Chave Torx E-28 para mancal de Scania Série 4



46628



Código	Medida	mm	g
46628	E28	55mm	588

Jogo de chave soquete 3/4" com 7 pçs



K6072



- Composição:
- 366080 60...100 5- Chave soquete Torx (80mmL) T60, T70, T80, T90, T100
 - 368080 16T, 18T 2- Chave soquete multidentado (80mmL) M16, M18

12/31.7/32.7/1.4' 2640g

Chave de roda ajustável



681600



- Dobrável - fácil de transportar e guardar.
- Deslizante - aumenta a força ajustando a alavanca.
- Soquetes longos.
- Medidas: 24/27/32mm & 3/4"SQ.DR. Comprimento: 600 mm

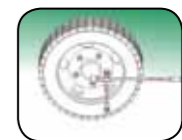

6/20.0/20.5/0.84' 3333g

Jogo de soquete estriado 1" com 14 pçs



8141



Código	Soquete	1/26.8/27.8/0.83'	26.8kg

- Composição: 1"DR.
- 589 36...80 10- Soquete estriado curto 36; 41; 46; 50; 55; 60; 65; 70; 75 80 mm
 - 80281 1- Catraca (cabeça)
 - 80381 1- Adaptador para cabo de força "T"
 - 8008550 1- Barra de apoio para catraca e cabo de força "T" - 550mmL
 - 8048 200...400 2- Extensão: 200; 400mmL



POWER IMPACT



WS-212T-8 1"



WS-212T-8

Mecanismo	Martelete duplo
Encaixe	1"
Capacidade	1-3/4"
Entrada de ar	3/8" (NPT)
Rotação livre	4800 (rpm)
Torque de trabalho	952-3270 (Nm)
Torque máx	3520 (Nm)
Consumo de ar	450 (l/min)
Pressão de trabalho	90 (psi)/6.2 (bar)
Peso/Comprimento	11.9 kg/570 mm

WS-2053 1/2"



WS-2053

Mecanismo	Martelete duplo
Encaixe	1/2"
Capacidade	9/16"
Entrada de ar	1/4" (NPT)
Rotação livre	12.000 (rpm)
Torque de trabalho	34 - 406 (Nm)
Torque máx	542 (Nm)
Consumo de ar	160 (l/min)
Pressão de trabalho	90 (psi)/6.2 (bar)
Peso/Comprimento	1.6 kg/140 mm

WS-2086 3/4"



WS-2086

Mecanismo	Martelete duplo
Encaixe	3/4"
Capacidade	13/16" (20mm)
Entrada de ar	1/4" (NPT)
Rotação livre	7.500 (rpm)
Torque de trabalho	68-1085 (Nm)
Torque máx	1490 (Nm)
Consumo de ar	220 (l/min)
Pressão de trabalho	90 (psi)/6.2 (bar)
Peso/Comprimento	2.68 kg/178 mm

Conjunto de eixo e martelos

Eixo e martelos feitos de aço níquel-molibdênio com tratamento especial para aumentar a vida útil

Gatilho

2 opções de mecanismos de gatilho: interno e externo



Bucha de admissão tipo reto



Gatilho interno



Gatilho externo

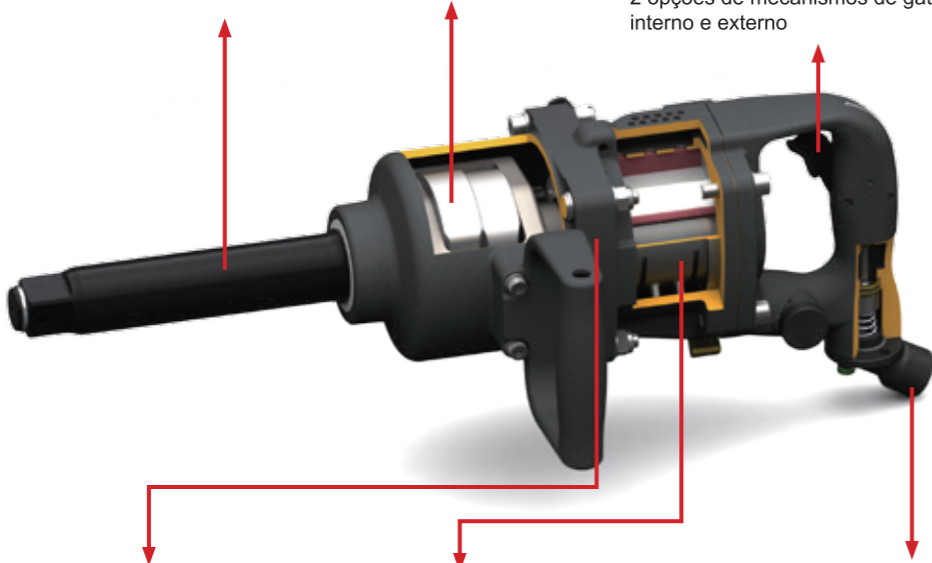

Carcaça

Carcaça sólida e robusta feita em liga de alumínio AC4C de alta qualidade

Motor

Motor com design compacto, sólido e de baixo consumo de ar

Bucha de admissão

3 opções de ângulo da bucha de admissão facilitando a operação do equipamento: Reto, 60 e 90 graus

WS-203E 1/2"



WS-203E

Mecanismo	Martelete duplo
Encaixe	1/2"
Capacidade	9/16"
Entrada de ar	1/4" (NPT)
Rotação livre	8.000 (rpm)
Torque de trabalho	34-540 (Nm)
Torque máx	759 (Nm)
Consumo de ar	200 (l/min)
Pressão de trabalho	90 (psi)/6.2 (bar)
Peso/Comprimento	2.6 kg/185 mm

WS-2068 1"



WS-2068

Mecanismo	Martelete duplo
Encaixe	1"
Capacidade	1-1/8" (30mm)
Entrada de ar	3/8" (NPT)
Rotação livre	7.500 (rpm)
Torque de trabalho	135-1500 (Nm)
Torque máx	2034 (Nm)
Consumo de ar	300 (l/min)
Pressão de trabalho	90 (psi)/6.2 (bar)
Peso/Comprimento	4.2 kg/213 mm

WS-2106  WS-2108 

WS-2106L  WS-2108L 





	WS-2106	WS-2106L	WS-2108	WS-2108L
Mecanismo	Martelete duplo	Martelete duplo	Martelete duplo	Martelete duplo
Encaixe	3/4"	3/4" (Eixo longo)	1"	1" (Eixo longo)
Capacidade	1-1/8" (30mm)	1-1/8" (30mm)	1-1/8" (30mm)	1-1/8" (30mm)
Entrada de ar	3/8" (NPT)	3/8" (NPT)	3/8" (NPT)	3/8" (NPT)
Rotação livre	7.500 (rpm)	7.500 (rpm)	7.500 (rpm)	7.500 (rpm)
Torque de trabalho	135-1500 (Nm)	135-1500 (Nm)	135-1500 (Nm)	135-1500 (Nm)
Torque máx	1898 (Nm)	1627 (Nm)	2034 (Nm)	1763 (Nm)
Consumo de ar	300 (l/min)	300 (l/min)	300 (l/min)	300 (l/min)
Pressão de trabalho	90 (psi)/6.2 (bar)	90 (psi)/6.2 (bar)	90 (psi)/6.2 (bar)	90 (psi)/6.2 (bar)
Peso/Comprimento	4.5 kg/286.5 mm	5 kg/434 mm	4.6 kg/288.6 mm	5.4 kg/441.6 mm

Esmerilhadeira de válvula

NEW



WS-601K

- Ferramenta simples e altamente eficiente que esmerilha válvulas em segundos.
- O kit acompanha 5 ventosas que serve para maioria das válvulas: 16mm, 20mm, 30mm, 35mm e 45mm



WS-405

acompanha ventosas:
16mm / 20mm / 30mm / 35mm



WS-405	
Capacidade	Ø45mm máx.
Frequencia	3000 bpm
Entrada de ar	1/4"
Consumo de ar	100 (l/min)
Pressão de trabalho	90 (psi)/6.2 (bar)
Peso/Comprimento	1.55 kg/153.5mm

Palhetas:

Tipo comum: Baquelite
Tipo Oil Free: Plástico de material composto usado em engenharia aeroespacial

Bocal de sucção:

Desenhado com análise de fluido proporcionando uma alta eficiência de sucção e conector com giratório de 360 graus.

Motor pneumático:

Aço fundido FCD45 com alta resistência ao desgaste.

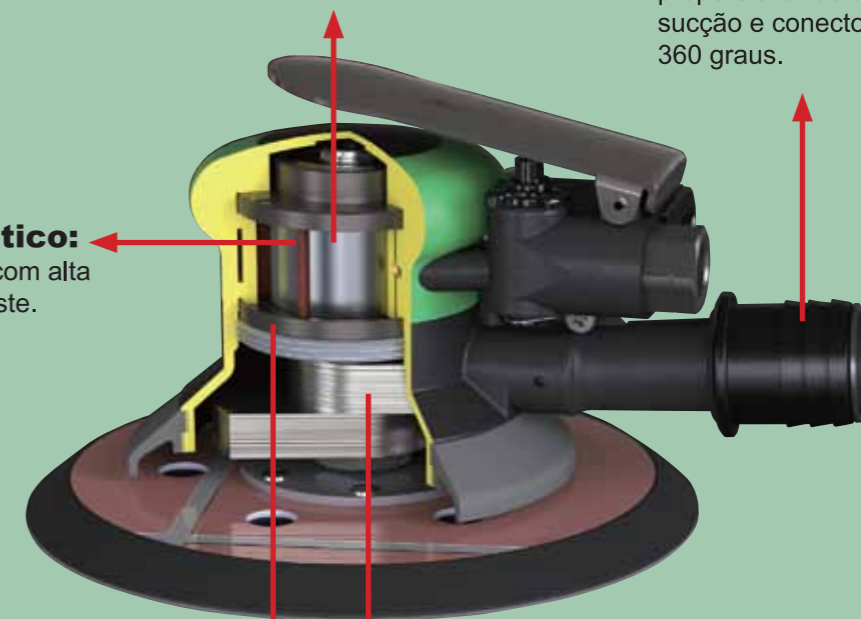

Rotor:

Tipo comum: Feito com aço SMF-4030 temperado que é altamente resistente ao desgaste.
Tipo Oil Free: Feito com material composto usado em engenharia aeroespacial de alta resistência e durabilidade, próprio para trabalhar em condições sem lubrificação.

Eixo:

Em estrutura de peça única fundido em molde com precisão resultando um equilíbrio dinâmico e baixo nível de ruído.

Lixadeira orbital com aspiração

WS-1051S-6HK





WS-1051S-6HK	
Diametro da base	6"
Rotação livre	12.000 (rpm)
Entrada de ar	1/4" NPT
Consumo de ar	170 (l/min)
Pressão de trabalho	90 (psi)/6.2 (bar)
Peso	0.85 kg



WS-515



Pressão de trabalho(Psi)
M3:25Psi, M4:45Psi, M5:75Psi, M6-M12:90-100Psi

Modelo	Capacidade de rebiteagem	Curso de repuxo	Força de tração (Máx.)	Altura	Peso	Consumo de ar	Vibração	Ruído
	mm	mm	Nm	mm	kg	LT	m/s2	db(A)
WS-515	M3~M12	0 - 6.5mm	21,000	310	2.5	7.5	<2.5	<80

- Pressão de trabalho: 90 psi (6.2bar)
- Entrada de ar: 1/4" PT ou NPT
- Mangueira: 1/4" (6.35mm)



WX-550
WX-5503



WX-551
WX-5513



Modelo	Capacidade de rebiteagem	Material do rebite	Capacidade máx. de rebiteagem		Força de tração	Curso de repuxo	Consumo de ar	Diâmetro do rebite	Peso	Pressão de trabalho	Dimensões LxWxH	Ruído
			AL. & Aço	Aço Inox								
	in (mm)		mm	mm	lbs(kgs)	mm	CFM	mm	kgs	psi	mm	dB(A)
WX-550 (2 castanhas) WX-5503 (3 castanhas)	3/32~3/16 (2.4~4.8)	Alumínio/ Aço / Aço Inox	4.8	4	1950 (885)	14	3.5	2.4, 3.2, 4.0, 4.8	1.5	60-100	160x 77x 275	82
WX-551 (2 castanhas) WX-5513 (3 castanhas)	3/32~1/4 (2.4~6.4)		6.4	5.6	3110 (1413)	19	4.2	2.4, 3.2, 4.0, 4.8, 6.4	2	80-100	180 x 90x 320	86

- Pressão do ar: 90 psi (6.2bar)
- Entrada de ar: 3/8" (9.5mm)



WS-511

Rebitadeira para rebite de rosca



WS-511

Capacidade	M6 - M8
Rotação livre	600 (rpm)
Consumo de ar	220 (l/min)
Pressão de trabalho	90 (psi)/6.2 (bar)
Entrada de ar	1/4" (NPT)
Mangueira de ar	3/8"
Peso/Comprimento	1.26 kg/ 198 mm



Mini chave catraca

82421



FORCE

82421

Encaixe	1/4"
Entrada de ar	1/4" (NPT)
Rotação livre	250 (rpm)
Torque de trabalho	20 - 27 (Nm)
Torque máx	33 (Nm)
Consumo de ar	68 (l/min)
Pressão de trabalho	90 (psi)/6.2 (bar)
Peso/Comprimento	0.45 kg/125 mm

Soartec

WX-6001

Capacidade	1/4"
Entrada de ar	1/4" (NPT)
Rotação livre	22.000 (rpm)
Consumo de ar	114 (l/min)
Pressão de trabalho	90 (psi)/6.2 (bar)
Peso/Comprimento	0.62 kg/175 mm

Retífica pneumática



WX-6001

Chave catraca

82443



FORCE

82443

Encaixe	1/2"
Entrada de ar	1/4" (NPT)
Rotação livre	200 (rpm)
Torque de trabalho	7-95 (Nm)
Torque máx	108 (Nm)
Consumo de ar	85 (l/min)
Pressão de trabalho	90 (psi)/6.2 (bar)
Peso/Comprimento	1.17 kg/260 mm

Soartec

WS-638AL

Capacidade	1/4"
Entrada de ar	1/4" (NPT)
Rotação livre	22.000 (rpm)
Consumo de ar	220 (l/min)
Pressão de trabalho	90 (psi)/6.2 (bar)
Peso/Comprimento	0.7 kg/172 mm



WS-638AL

Acessórios

WX-2814



Soartec

WX-2814

Encaixe	1/2"
Entrada de ar	3/8" (NPT)
Rotação livre	160 (rpm)
Torque de trabalho	55 - 75 (Nm)
Torque máx	80 (Nm)
Consumo de ar	240 (l/min)
Pressão de trabalho	90 (psi)/6.2 (bar)
Peso/Comprimento	1.2 kg/254 mm



20-SF

Engate rápido rosca fêmea

- Sistema One Touch
- Construído em Nylon
- Leve e resistente
- Alta vazão de ar



20-PM

Pino para engate rápido

Martelete pneumático

WS-402-190K



Soartec

WS-402-190K

Velocidade	3.200 (bpm)
Entrada de ar	1/4" (NPT)
Consumo de ar	210 (l/min)
Pressão de trabalho	90 (psi)/6.2 (bar)
Peso/Comprimento	1.6 kg/180 mm



Manguera espiral em Poliuretano (PU) - 8x12 - 12m